

Manual Ceilometer CHM 15k „NIMBUS“

· a passion for precision · passion pour la précision · pasión por la precisión · passione per la precisione · a

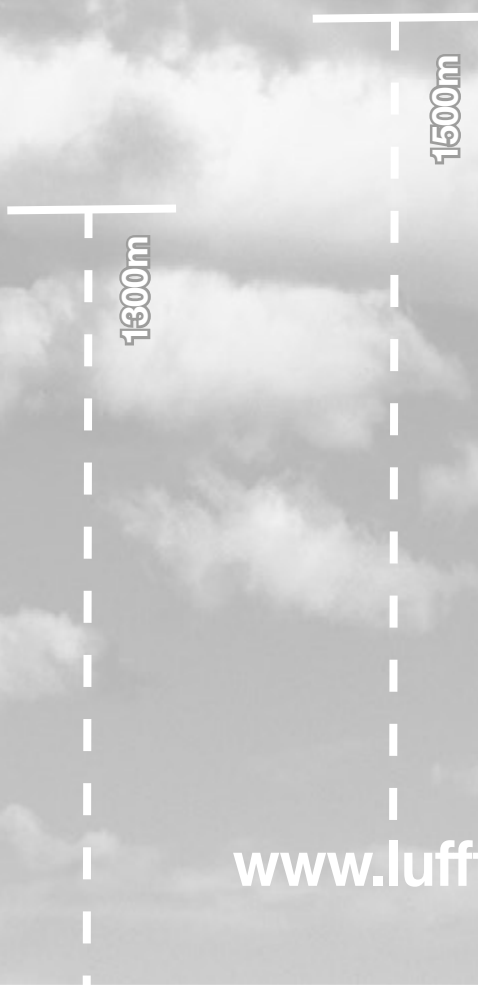

Jenoptik Laser Technology Inside

www.lufft.com



You are advised to read this Manual carefully before you start using the CHM 15k Nimbus / CHM 15k-x ceilometer.

This is necessary to ensure that you will be able to utilize all the capabilities, which have been designed into the equipment.

This technology is subject to further development.

Documentation number: 8350.MEP

This documentation is valid for the following instrument types:

CHM 15k Nimbus series with order numbers: 8350.00, 8350.01, 8350.03

G. Lufft Mess- und Regeltechnik GmbH

Gutenbergstr. 20

70736 Fellbach / Germany

Phone: +49 (711) 51822-831

Fax: +49 (711) 51822-944

E-mail: info@lufft.de (Info & Sales)

E-mail: service@lufft.de (Support Lufft Berlin)

Date	Revision	Comment
March 2014	I0	Firmware 0.723, last Jenoptik release
September 2014	R02	Firmware 0.724, Lufft design, 10m range resolution in NetCDF available, small corrections
December 2014	R04	Firmware 0.730, cloud algorithm optimized in precipitation cases, parameter in RS485 / web-interface added, chapter 7-8 corrected
May 2015	R05	Firmware 0.732
October 2015	R06	Firmware 0.735, small fixes
November 2015	R07	Small fixes chapter 9, table SCI
April 2016		coming soon



Note

This Manual is protected by copyright. No part of the Manual may be reproduced in any way (by photographing, photocopying, microfilm or any other technique) without the prior written approval of G. Lufft, nor may it be processed, duplicated or disseminated with the help of electronic systems. Any offence against these rules will be prosecuted.

Proper care was used in compiling this document. No liability will be accepted in the event of damage resulting from failure to comply with information provided herein.

1	Basic Information	5
1.1	Manual Structuring & Layout Note	5
1.2	Intended Use	5
2	Safety	7
2.1	Standards & Directives	7
2.2	General Safety Measures	7
2.3	Safety Notes Regarding the Laser System	7
2.4	Requirements on Personnel	8
2.5	Safety Notes Regarding Transportation, Installation, Commissioning & Cleaning	8
2.6	Safety Labelling	9
2.6.1	User Manual	9
2.6.2	CHM 15k	10
3	Technical Data	11
4	Technical Description	13
4.1	Setup of CHM 15k	13
4.2	Functional units in inner casing space	14
4.2.1	Functional Chart	15
4.2.2	Measuring and monitoring	16
5	Transportation & Scope of Delivery	17
6	Installation	19
6.1	Installing the CHM 15k	19
6.1.1	Preparatory Work	19
6.1.2	Installation on the Mounting Base	20
6.2	Electrical Installation	23
7	Starting Up & Shutting Down	25
7.1	Starting Up with serial connection RS485	25
7.2	Starting up with LAN connection	27
7.3	Shutting Down	28
7.4	Disposal	28
8	Communication RS485 & Ethernet	29
8.1	List of configurable instrument parameters	29
8.2	Instrument Configuration using RS 485 interface	33
8.2.1	Reading a parameter	34
8.2.2	Setting a parameter	35
8.2.3	Change in Baud Rate	35
8.2.4	Reboot of embedded linux system/ reset to factory settings	36
8.2.5	Changing the logging time dt(s), date & time	36
8.3	Data Queries RS485	36
8.3.1	Polling Mode	37
8.3.2	Automatic Output Mode	37
8.3.3	Standard Data Telegram	38
8.3.4	Extended Data Telegram	40
8.3.5	Raw Data Telegram	43
8.3.6	User configured data telegrams	45

8.4	NetCDF Format Structure	46
8.4.1	General	46
8.4.2	Fundamentals	46
8.4.3	File Names	46
8.4.4	Format Structure	47
8.5	Service Codes	51
8.6	Firmware Update	52
8.7	Communication via Ethernet - Web-Interface	53
8.7.1	Time Server	58
8.8	AFD Mode	58
8.9	Telegram over Ethernet	61
9	Data Evaluation/ Sky Condition Algorithm (SCA)	63
9.1	Laser remote sensing	63
9.2	Data preprocessing and averaging	63
9.3	Cloud ceilings/ cloud base heights	64
9.4	Cloud Penetration Depth	65
9.5	Determination of Maximum Detection Range	65
9.6	Vertical optical range	66
9.7	Precipitation and haze	66
9.8	Mixed layer height	66
9.9	Parameters for data evaluation	67
9.10	Cloud amount/ cloud cover (BCC / TCC)	67
9.11	Sky condition index (SCI)	68
10	Cleaning, Maintenance & Service Instructions	71
10.1	Cleaning	71
10.2	Maintenance Intervals & Action	73
10.2.1	Replacement of Air Dehumidifier Bag [67]	73
10.2.2	Replacement of Rubber Seal [34] at Inner Door	73
11	DataClient - Terminal software for CHM 15k	75
11.1	Software Installation	75
11.2	Convention for the file names	75
11.3	Start dialog	76
11.4	Communication tab	77
11.5	Raw Data	79
11.6	Telegram & Cloud Layer	80
11.7	Service Code	81
11.8	Service & Software Update	82
11.9	General available controls or indicators	82
11.10	Autostart and command line parameters	83
11.11	DataClient Software Versions	85
Annex		87
List of Illustrations		96
List of Tables		98
Declaration of Conformity		99

1 Basic Information

This User Manual provides the information that is required to operate the CHM 15k Cloud Height Meter.

1.1 Manual Structuring & Layout Note

The Manual consists of eleven chapters, each page indicating the chapter title in its headline. The bottom line of each page contains the details of the revision state, date of issue and page number. In the appendix a content list of the service manual, a list of software releases for this manual revision and a configuration example is applied.

1.2 Intended Use

Operating safety can only be guaranteed when the CHM 15k Cloud Height Meter is operated as intended and in accordance with the information contained in this Manual.

The CHM 15k is only intended for single-phase operation powered by a public low-voltage distribution system as stipulated in IEC38, 6th revision of 1983.

The Cloud Height Meter may be used with a maximum tilt angle setting of 20 degrees. Any angle setting in excess of this limit will be regarded as non-conforming use! The owner (operator) will be solely responsible in the event of damage due to non-compliance of this kind.

You are strictly prohibited from using the CHM 15k in a horizontal position.

For proper operation, scheduled cleaning and maintenance cycles must be observed (refer to chapter 10 of this Manual or to the Service Manual).

2 Safety

2.1 Standards & Directives

To guarantee the safe operation of laser devices, all binding standards, directives and instructions regarding laser safety and laser radiation protection must be observed by manufacturers and users (refer to Declaration of Conformity).

The CHM 15k Cloud Height Meter is built and tested for compliance with the following standards and directives:

1. Council Directive 2004/108/EEC
on the approximation of the laws of the Member States relating to electromagnetic compatibility (EMC),
conforming to EN 61326 and EN 55011 standard requirements
2. Council Directive 2006/95/EEC
relating to electrical equipment designed for use within certain voltage limits (73/23/EEC)
conforming to the following standards:
 - EN 60825-1; Safety of laser products
 - EN 61010-1; Safety requirements for electrical equipment for measurement, control and laboratory use

In accordance with EN 60825-1:2007 and its inherent risk potential, the CHM 15k qualifies as a class 1M laser device.

2.2 General Safety Measures

- All safety notes in this User Manual, including any other applicable documents, must be duly observed and followed.
- This User Manual must be kept within easy reach of personnel at all times.
- The CHM 15k may only be operated with the inner door closed.
- The CHM 15k Cloud Height Meter may not be powered by nominal voltages other than 230 VAC.

2.3 Safety Notes Regarding the Laser System

There is invisible 1064-nm laser radiation emerging from the CHM 15k. It emits a laser beam of very small divergence (< 0.5 mrad) and 90 mm beam diameter.

- Do not directly look into the beam.
- Avoid unnecessary exposure to invisible laser radiation.
- It is strictly forbidden to use optical instruments, notably, field glasses, for viewing the laser beam.
- **Class 1M laser radiation, if viewed over an extended period of time, may cause damage to the eyes such as glare or irritation or even full loss of eyesight.**
- Make sure the laser beam path is free from material with reflecting surfaces.
- Follow all instructions especially those on emergence of laser radiation (also

refer to chapter 2.6 Safety Labelling).

2.4 Requirements on Personnel

- The CHM 15k may only be installed and commissioned by properly trained personnel who have received instructions on operating safety.
- Maintenance or adjustment work on the CHM 15k may only be carried by G. Lufft GmbH service personnel or specially trained and authorized technicians of the Customer.
- Anyone who is entrusted with work to install and commission the CHM 15k must have completely read and understood this Manual.
- Personnel working with the CHM 15k must not be in a state of fatigue or under the influence of alcohol or medication or have physical impairments of any kind that might temporarily or lastingly restrict their attention or judgement.

2.5 Safety Notes Regarding Transportation, Installation, Commissioning & Cleaning

- For handling, shipment or transportation, the CHM 15k must be duly packaged and placed in the transporting position (refer to Fig. 5). Adequate hoisting equipment and an appropriate means of transportation must be used in all cases.
- Once packaged, the CHM 15k must be secured and protected against accidental shifting, mechanical shock or other similar impacts that may occur inside the selected means of transportation, for example, by using tension belts.
- A packaged CHM 15k must not be stacked.
- The CHM 15k requires a footprint area of 50 x 50 cm. It must be installed and assembled in a stable and fixed position on a suitably sized concrete foundation. The maximum permitted inclination angle of the mounting base is 5 mm/m.
- If the CHM 15k is not intended to be assembled immediately, it must be protected from external influences and securely stored.
- For installation, the following minimum prescribed clearances must be kept between the CHM 15k and:
 - mobile phones 2,5 m
 - stationary emitters, ground stations (≥ 100 W of output power) 25 m
 - a second cloud height meter (to prevent optical interferences) 10 m
- Prevent irradiation from strong light sources.
- The angle of insolation must be less or equal 15 degrees against the vertical line. Please ask for a suitable adapter plates.
- The assembly site must be at a great enough distance from tree plantations or shrubbery to prevent leaves or needles restricting the cloud meter's light outlet openings.
- At least two persons are required for installation of the CHM 15k.
- On completion of installation work, ensure that no safety-relevant changes

have impacted the CHM 15k during installation.

2.6 Safety Labelling

2.6.1 User Manual

Throughout this Manual the following pictograms and signal words are used:

DANGER

Warns of laser radiation



CAUTION

Warns of potential damage



NOTE

Important general note



NOTE

Important note on environmental protection



2.6.2 CHM 15k

Product labelling is as follows (see Fig. 1):

- 4 warning labels with safety notes
- 1 plate with performance data
- 1 "Beware of Laser Radiation" warning label
- 1 type plate (rear side)

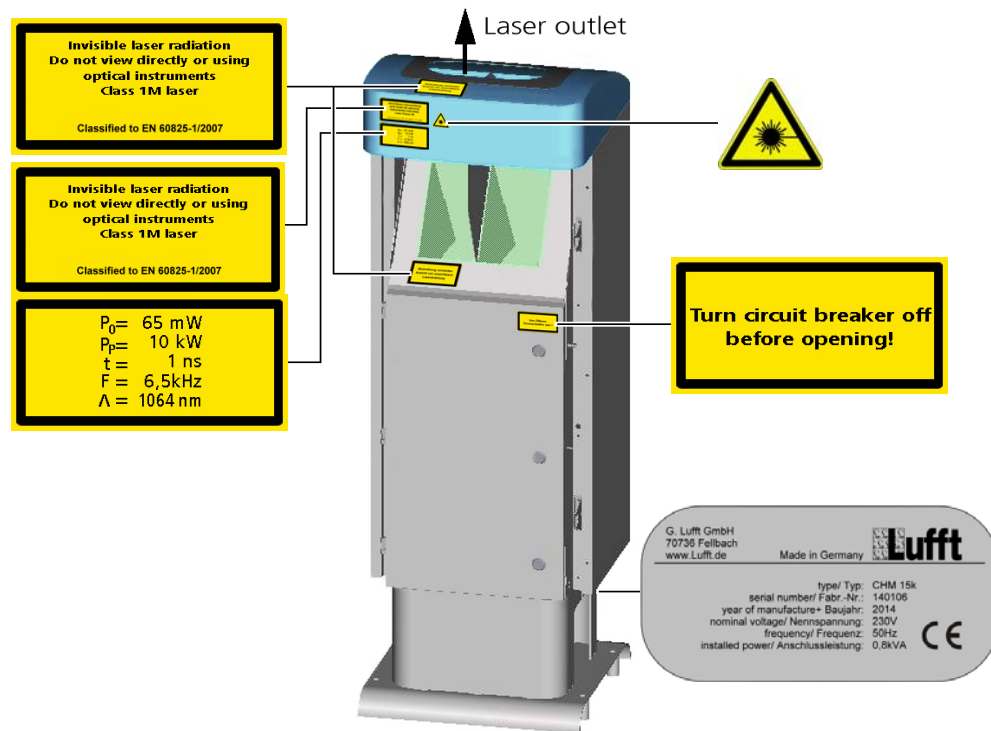

Fig. 1: Labelling

3 Technical Data

Measurement parameter	
Measuring range	5 m - 15 km (15 – 50,000 ft)
Range Resolution	5 m (16 ft) measurement 15 m (full range resolution in NetCDF file) 5 m (5 m - 150 m near field range resolution in NetCDF file)
logging time & reporting cycle	2 s to 600 s (programmable), standard values are: 15 s, 30 s, 60 s
Targets	aerosols & clouds (droplets, ice crystals)
Measurands	backscatter raw data cloud base height up to 9layers incl. penetration depth (cloud thickness), max detectable range (MXD), vertical visual range (VOR), sky condition (SCI), cloud amount (TCC, BCC),...
Measuring principle	lidar (light detection and ranging)
Laser-optical parameters	
Light source	laser, laser protection class 1M under EN 60825-1
Wavelength	1,064 nm
Bandwidth	0.1 nm
Pulse duration	1 ... 5 ns
Pulse repetition rate (PRF)	5 – 7 kHz
Beam diameter (1/e ²)	expanded to: 90 mm
Laser divergence	< 0.3 mrad
Energy per pulse	7 -9 µJ
Long-time stability over 12 months (pulse repetition rate)	< 10 %
Pulse-to-pulse variance of laser energy	< 3 %
FOV Receiver	0.45 mrad
Data interfaces	
Communication interfaces	RS485 & LAN Optional: DSL, RS232 or modem V.21, V.22, V.22bis
Electrical parameters	
Nominal voltage	230 VAC, ±10 % optional: 100, 115VAC ±10 %
Line frequency	50 Hz
Max. power consumption	0.8 kW in maximum (all heater are running)
Optional: Backup battery	>1 hour support of integrated electronics

Table 1: Technical data

Technical Data

Operating safety	
Environmental compliance	ISO 10109-11
Protection class	1
Internal protection standard	IP 65
EMC	EN 61326 class B
Light source	Laser protection class 1M under DIN EN 60825-1
Certification	CE
Operating conditions	
Temperature range	-40 °C to +55 °C
Rel. air humidity	0 % to 100 %
Wind	55 m/s
Physical dimensions	
Dimensions of casing	W x H x L = 0.5 m x 0.5 m x 1.55 m
Packed dimensions	W x H x L = 0.65 m x 0.8 m x 1.67 m
Weight	70 kg (complete system)
	9.5 kg (laser optical unit - heaviest spare part)
Installation requirements	
Suitable low-voltage distribution systems	TN-S-system: grounded supply network, CHM 15k casing grounded, neutral and protective conductor as separate wires TN-C-system: CHM 15k casing grounded, neutral and protective conductor in one single wire
Type of connection	Non-detachable connection
Requirements to be met by Owner/Operator	
Lightning protection	External lightning protection to DIN V VDE 0185-3
Grounding	Grounding system to DIN V VDE 0185-3
Requirements for outdoor installation	<ul style="list-style-type: none"> - Circuit breaker to cut low-voltage power supply, installed near the CHM 15k - Within easy reach - Clearly marked as a part of CHM 15k - Back-up fuse matched to wire cross-section ≥ 6 A, B or C

Table 1: Technical data

4 Technical Description

The CHM 15k Cloud Height Meter is intended to measure clouds at a maximum height of fifteen kilometers, to determine cloud layer penetration depth and vertical visibility.

The measured data set is transmitted by digital standard interfaces. The CHM 15k uses the Lidar technique (Lidar: **L**ight **d**etection **a**nd **r**anging, refer to chapter 9.1) to emit short light pulses into the atmosphere. These are scattered back by aerosols and air molecules. The pulse flight time and intensity of a backscattered light signal are then analyzed. Using this data as input, aerosol or cloud layers can be assigned in terms of height and visibility levels can be determined.

The CHM 15k Nimbus working is based on a photon counting method. Compared to analog measurement techniques, the benefits of this method are very high detection accuracy and sensitiveness which makes it particularly suited for applications using lidar technique. This equally refers to the useful signal and to potential "noise signals", for example, background light.

Engineering design features of the CHM 15k

The CHM 15k Cloud Height Meter is:

- of compact design
- operational in climatic conditions as specified in Table 1
- of modular setup

4.1 Setup of CHM 15k

The CHM 15k is enclosed by a double-shell casing of corrosion-resistant aluminium. The purpose of the outer shell is to reduce and prevent potential external influences such as:

- solar radiation
- wind
- rain
- snow

from effecting the inner casing shell that carries the measuring unit. There is a chimney effect between the outer shell and the inner shell to support this process.

The top cover protects the inner casing shell from dirt and precipitation.

An opening for laser beam outlet and inlet is machined into this cover. A partition panel inside the top cover separates the emitter module from the receiver module and an air deflector in the interior cover space directs the air stream from the two fans onto the glass panels in the inner casing shell.

The inner casing shell contains all equipment parts for CHM 15k operation. The cable ports for data line, current supply, grounding and power supply of the external fans are designed as compression glands. For pressure equalization, the inner casing shell includes a pressure-balancing component with a Goretex membrane.

Integrated into the top wall of the inner casing shell is a split-area vision panel of

neutral-color float glass. Both vision panels are somewhat inclined in keeping with the Brewster angle. This ensures that laser light will suffer only minimal loss as it passes through and the vision panels remain in an optimal condition due to a self-cleaning effect. This effect is supported by the fans which are located on the back panel of the equipment. The fans cut in at hourly intervals or when there is rain or snow. The two fans are also intended to remove the heat from the inner casing space.

For maintenance of the fans, the back wall panel of the CHM 15k has to be removed.

The outer door provides access to the inner casing shell and the glass panels for necessary cleaning. The outer and the inner door work on different locking mechanisms in order to avoid personal injury and to protect the internal components against improper acts. Persons who have not undergone any safety briefing shall not open the inner door.

4.2 Functional units in inner casing space

The functional units are:

- Emitter and receiver module (laser optic module - LOM)
- Central processing board and related components
- Laser controller module
- Power supply 12 - 15 VDC for electronics
- Power transformer 48 VDC for highly shielded outdoor fan
- Blower & heater
- Lightning & overvoltage protection system for power cable, LAN, RS485,

Each functional unit is of modular setup, separately fixed to the inner casing shell and can be individually retrieved for replacement or necessary service work.

4.2.1 Functional Chart

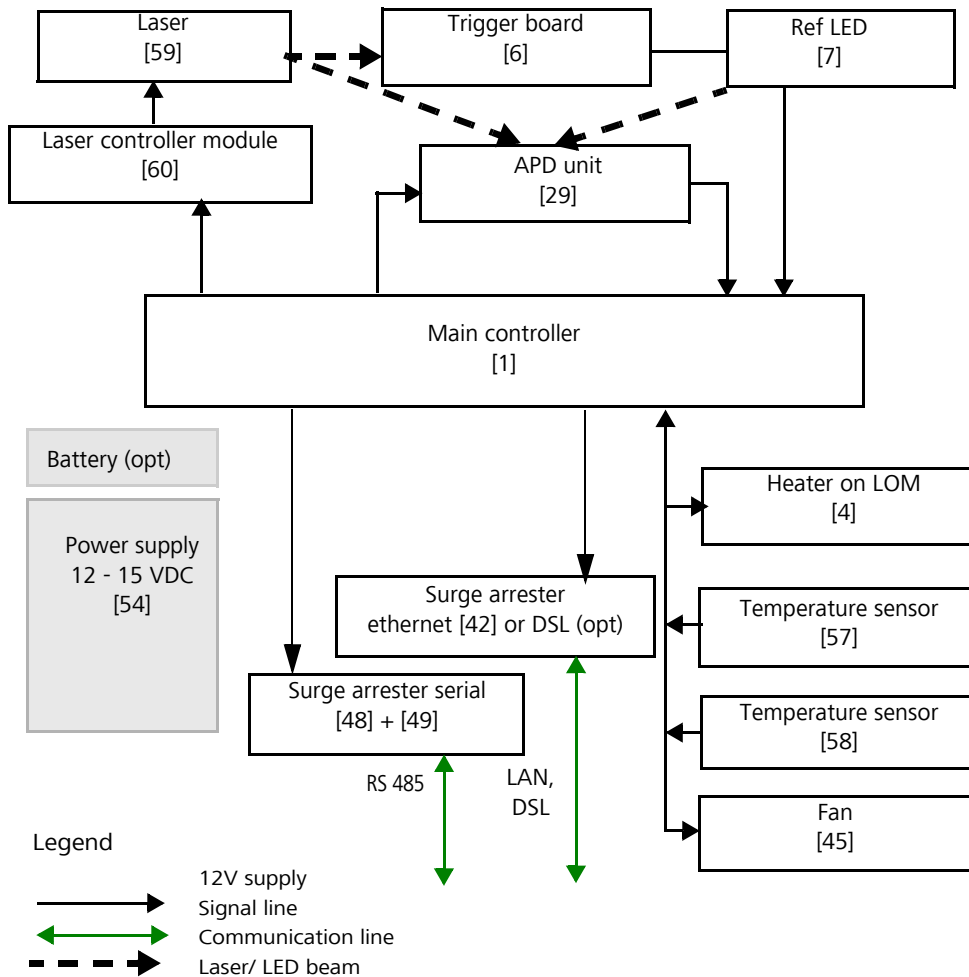

Fig. 2: Functional chart, the numbers in brackets corresponds to the numbering in the spare parts list (refer to service manual).

Figure 2 shows clearly that the "Main controller" is the central unit that monitors and controls all the sensors in operation.

4.2.2 Measuring and monitoring

The process monitoring is organized inside the FPGA and therefore independent from the Linux based ARM processor.

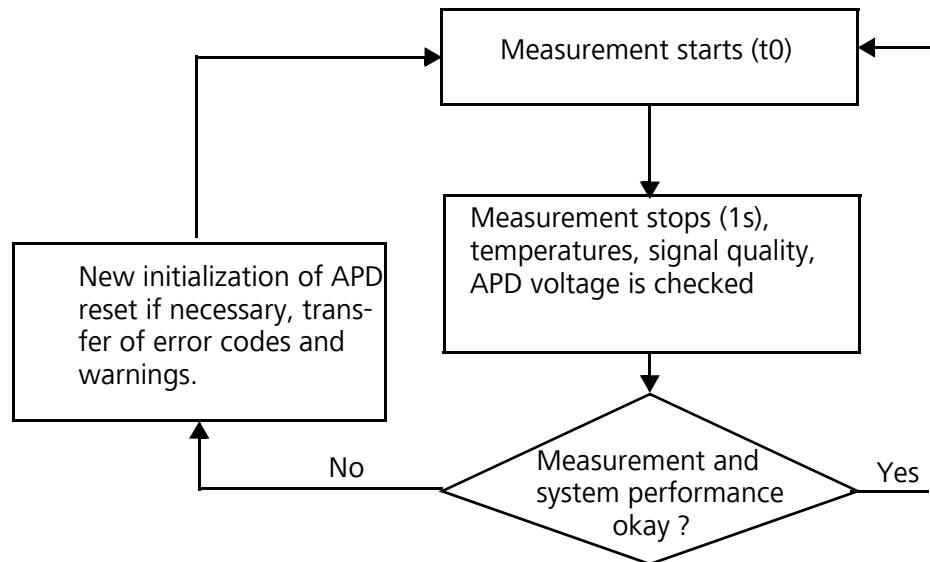

Fig. 3: Flowchart of measuring and monitoring processes inside the FPGA.

Figure 3 shows a standard measurement cycle. On completion of each measurement cycle (1s), data are checked and status parameters are evaluated. If a value is found to be out of tolerance or if a hardware error occurs, the standard measurement cycle will be re-initialized.

Cyclic standard measurement is monitored by an extra routine within the FPGA. The state of the receiver depends on the results of monitoring noise level, supply voltage and dc-current with and without a test pulse. Due to its internal setup, the light source is essentially characterized by the pulse repetition rate, which may decrease because of light source aging. The pulse rate is subject to monitoring. For pulse rates below 4.5 kHz, an error message is generated. The light pulse reflection from the window panel is also analyzed to monitor the window contamination.

All obtained values are output in an extended data telegram or inside the NetCDF files. The standard data telegram contains approximate information about the service code (refer to chapter 8.5).

5 Transportation & Scope of Delivery

CAUTION

Danger of damage!

The CHM 15k may only be transported and moved with the help of suitable lifting gear and an appropriate means of transportation.

The CHM 15k may only be loaded and transported in packaged condition and in the transporting position (see Fig. 5).

Inside its shipping container, the CHM 15k must be adequately protected against slipping, shock, stroke or other mechanical impacts.



The **scope of delivery** includes:

- CHM 15k Cloud Height Meter
- Drilling template
- Fastener components
 - 4 S12 wallplug/ anchor (e.g. from Fischer)
 - 4 DIN 571-10 x 140-ZN screws
 - 4 ISO 7093-10.5-KST/PA washers
 - 4 ISO 7093-10.5-A2 washers
- User manual and device software

If requested by the customer, an adapter frame can be delivered together with the equipment to allow the CHM 15k to be screwed onto prepared fastening bolts. Angle adapters, e.g. for 15° are also available upon request.

Imperial units information: Spanner/ wrench size for 4x M10 screws: 18 mm or 7/16 BSF or 3/8 Wworth. Instead of M10 screw an imperial 3/8 or 25/64 might be used together with appropriate anchors.



Please contact G. Lufft GmbH for further technical details.

Operating state at the time of CHM 15k product delivery:

Transfer mode 1	Automatic output of standard data telegram
Device code (device)	16
Baud rate	9,600
Duration of measurement	30 seconds

For further details on operating states, consult chapter 8.

6 Installation

CAUTION

There is danger of mechanical damage!

The owner/operator of the CHM 15k will be responsible for dimensioning and manufacturing a concrete base. This mounting base must be properly sized to withstand the lasting strain that is caused by the equipment's own weight and by external influences.



CAUTION

There is danger of mechanical damage!

The device must not be opened during work for setting up or starting up, in order to prevent the penetration of dirt or humidity. If opening becomes necessary, e.g. following a malfunction, work of this kind may only be performed by duly instructed personnel.



The CHM 15k Cloud Height Meter is assembled and fixed on a suitably sized concrete foundation.

Levelling screws are integrated with the bottom of the support legs to allow for vertical adjustment and, hence, vertical adjustment of the measuring unit.

6.1 Installing the CHM 15k

6.1.1 Preparatory Work

Before CHM 15k installation may begin, diameter 12 holes and dowels (4 dowels included in delivery) have to be made and inserted in accordance with the drilling template (Fig. 4).

Make sure that the outer door is properly oriented for power connections to the power box of the operator.

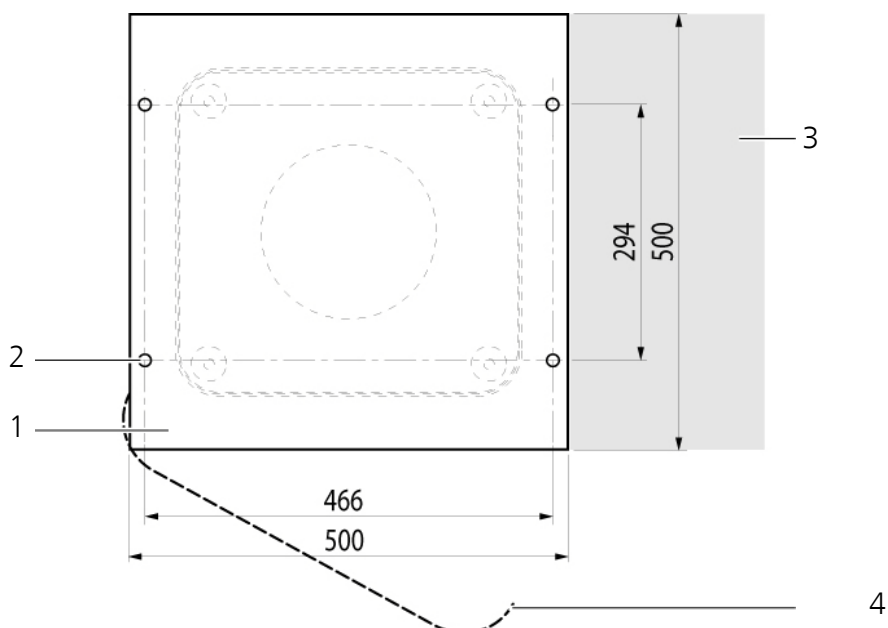

Fig. 4: Drilling template

- 1 Drilling template
- 2 Holes (15 mm in diameter) for mech. attachment
- 3 Power supply port (for connection box)
- 4 Opening direction of outer door

6.1.2 Installation on the Mounting Base



CAUTION

There is danger of accidents during installation work!

The weight of the CHM 15k amounts to 70 kg. For this reason, at least two persons are required to assemble the Cloud Height Meter.

To install the CHMK 15k Cloud Height Meter, proceed as follows:

1. Unload the CHM 15k from its means of transportation, using appropriate lifting gear and place it down as near as possible to the designated installation.



Fig. 5: The CHM 15k packaged and in transporting position

- 1 Packaging of wooden
 - 2 Pallet
2. Remove packaging
 - Screw the side walls
 - Remove the sidewalls separate



Fig. 6: The CHM 15k with styrofoam packing pads

- 1 Styrofoam packing pads
 - 2 CHM 15k
 - 3 Pallet
3. Cautiously lift the CHM 15k out of the styrofoam packing pads by hand. Comply with all safety regulations as you do this (Position for raising: Fig. 8).

Relocation/further transportation options:

- By sack barrow: with bigger distances to concrete base (Fig. 7)
- Manual transportation: put your hands into the openings which marked with arrows (Fig. 8) for this purpose

CAUTION

**There is danger of damage to the Cloud Height Meter!
Make sure that the CHM 15k is transported with the outer door facing down (Fig. 7) when loaded onto a sack barrow.**





Fig. 7: Transporting by sack barrow

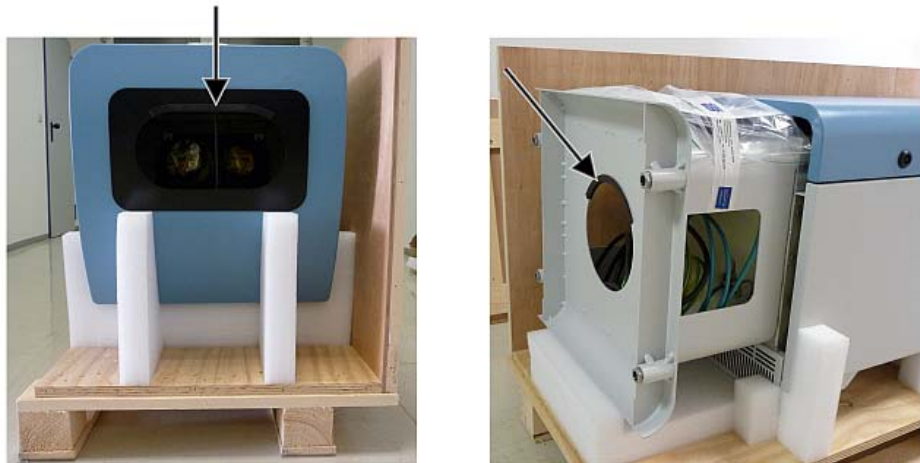

Fig. 8: Position for raising

4. Place the CHM 15k in the mounting position (vertical) onto its concrete base. As you do this, pay attention to the outer door position in relation to the local power connection box (see Fig. 4).
5. Use the washers and screws (supplied) to pre-assemble the CHM 15k (see Fig. 9) so it is preliminarily fixed on its concrete base.

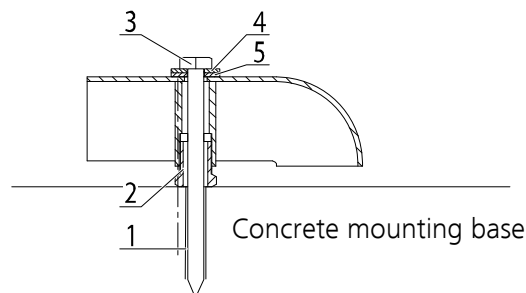

Fig. 9: Fasteners

- 1 S12 dowel
 - 2 ± 5 mm levelling screw (integrated into the device foot)
 - 3 DIN 571-10 x 140-ZN screw
 - 4 ISO 7093-10,5-A2 washer
 - 5 ISO 7093-10,5-KST/PA washer
6. Turn the levelling screws (integrated with the support legs) until the CHM 15k is properly aligned in a vertical direction (using a water-level placed onto a side wall or the front face).
 7. Tighten fastening screws (nuts).

6.2 Electrical Installation

CAUTION

There is risk of damaging the Cloud Height Meter!
Work for connection of the CHM 15k to electric power supply may only be carried out by an electrician of ESW GmbH or another specialist electrician. Failure to comply will void any claims of guarantee or warranty.



NOTE

It is the operator's responsibility to create all preconditions that are required for CHM 15k Cloud Height Meter connections according to EN 61016-1, e. g. he must install a connection box.



Installed connections must be in accordance with the valid national regulations.
 A power connection box may be installed directly beside the CHM 15k or at a distance < 3 meters.

Electrical connection of the CHM 15k requires non-detachable cabling as follows:

1. 10 mm² grounding cable (1-pole, green-yellow), 3 meters.
2. Data cable (RS 485); A (+) conductor: green, B (-) conductor: red, earth-ground: cable shield, 3 meters.
3. Data cable (LAN); The cable is equipped with a standard RJ45 plug to connect to a remote computer, hub or switch, standard length 5 or 10m.
4. 230 V supply (power supply: neutral conductor: blue; conductor: brown; grounding conductor: green-yellow), 3 meters.

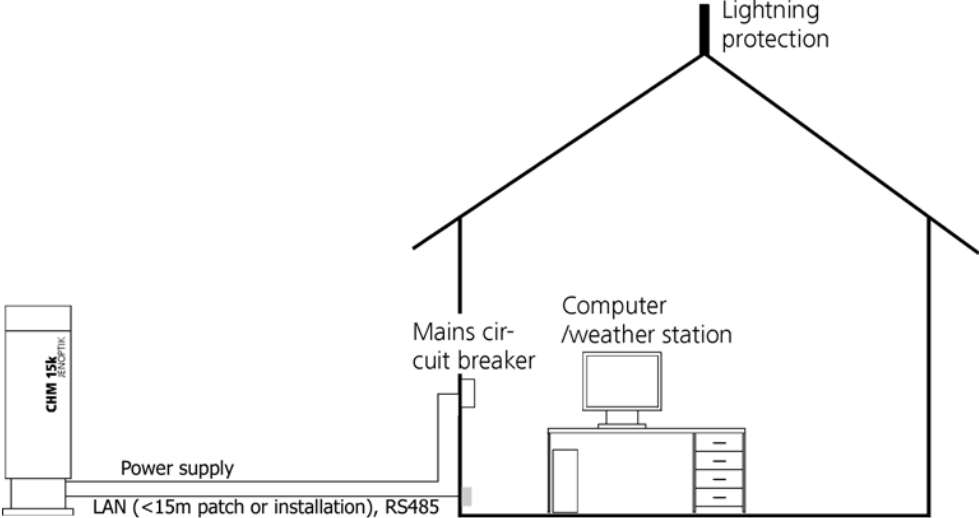

Fig. 10: Principal diagram

7 Starting Up & Shutting Down

7.1 Starting Up with serial connection RS485

Preconditions

- The CHM 15k Cloud Height Meter has been installed in a conforming manner.
- The control cable (RS485), ground cable and power cable (230 V) are connected.
- For communication checks, a terminal program, e.g. a hyper terminal working under Windows is available. It has been configured for communication as follows:
 - Baud rate: 9,600
 - Data bits: 8
 - Parity: none
 - Stop bits: 1
 - Flow control: none

DANGER

Laser radiation! There is danger of eye injury!

Once power is on, the CHM 15k emits invisible laser radiation. Don't directly look into the laser beam. Under no circumstances may the laser beam be observed using optical instruments (field glasses).



Starting conditions

After the on-site mains circuit breaker has been turned into power-on position, the CHM 15k will start up by itself. It will be fully operational after a temperature adjustment phase of varying length. Depending on outdoor temperatures, this phase may last from a few minutes to one hour (at 40 °C below zero).

NOTE

Following a short-time power failure (for a few seconds), no warming-up phase is required. The CHM 15k will be fit for use again after two minutes.



Communication with the CHM 15k will be possible if a minimum temperature of 0 °C is reached in its inner space.

System state query via RS485

Operating state of the CHM 15k at the time of delivery:

- Automatic output of standard data telegram
- RS485 ID number 16
- Baud rate 9,600
- Measuring time: 30 seconds

For further detailed information about operating states, refer to chapter 8.

For testing of communication, use a

set<SPACE><RS485No>:Transfermode=0<CR><LF>

command. It will switch to polling mode.

Working in this mode, you are able to test the following three types of telegram:

- Standard data telegram
- Extended data telegram
- Raw data telegram

and make device settings as may be required. Chapter 8 describes available commands and their effects in detail.

Table 2 shows the most important commands that are necessary to perform simple function tests in routine mode.

Command	Description	Reply (shortened)
get<SPACE>16:L<CR><LF>	Poll for extended data telegram	refer to chapter 8.3.4
set<SPACE>16:RNO=14<CR><LF>	Changes RS485 number from 16 to 14	set 16:RNO=14
set<SPACE>16:Baud=4<CR><LF>	Sets baud rate to 19,200	set 16:Baud=4
set<SPACE>16:dt(s)=15<CR><LF>	Sets logging time to 15 seconds	set 16:dt(s)=15
get<SPACE>16:Lifetime(h)<CR><LF>	Queries laser operating time in hours	get 16:Lifetime(h)

Table 2: Essential commands for function testing (examples)

On completion of simple function testing: of the CHM 15k:

- continue to operate the CHM 15k in polling mode or
- set it back to automatic transfer mode

set<SPACE><RS485No>:Transfermode=1<CR><LF>

Note: This command refers to automatic transfer mode.



NOTE

Pay special attention to the baud rate setting for RS485 bus operation. If you operate the system in raw data transfer mode, you should set the baud rate at least 19.200 Baud for a short transmission time of telegrams.

7.2 Starting up with LAN connection

Additionally or instead of the RS 485 connection a LAN connection (Ethernet) can be used.

Precondition: LAN cable is connected (see chapter 6.2)

Configuration: 3 IP addresses are available at the same time for communication:

1. a pre-configured fixed service address to the CHM 15k Nimbus
 - 192.168.100.101, Subnet 255.255.255.0
2. DHCP server allocation (DHCP server required)
3. user address + subnet + gateway (See chapter 8.7 for configuration with LAN / WAN access to the instrument and chapter 8.1 and 8.2 if you configure these values using the RS485 interface)

The service address (1) can not be modified by the user. It is always available and can be used for direct connections between a laptop and the CHM 15k Nimbus. The address (3) can be entered in a web browser window (Fig. 11) to communicate with the instrument. Fig. 15 shows the "Config Network" tab in the Firefox web browser. Superuser authorization is required to change the user IP address (3).

Super user password: 15k-Nimbus

The web interface was tested with the following web-browsers:

- Internet Explorer 8
- Firefox 3.6
- Google Chrome
- Apple Safari

In DHCP (2) network environments the CHM device is automatically configured. A portscan utility can help to find the address.

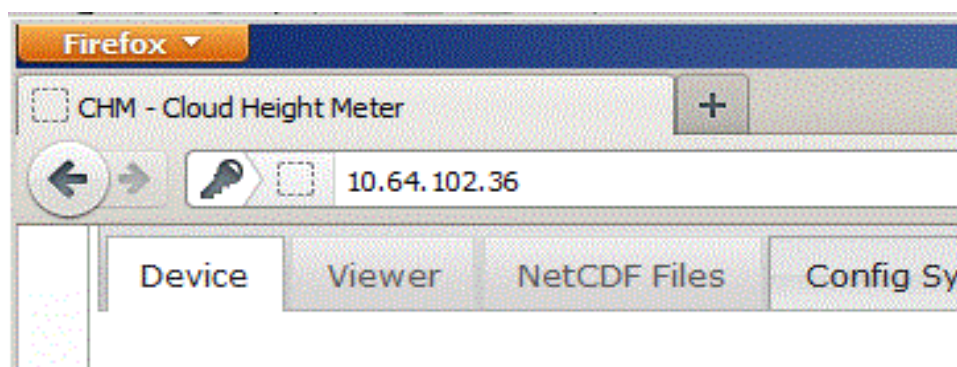

Fig. 11: Firefox browser to access to a CHM 15k Nimbus instrument (here with a fixed address).

Another comfortable way is to use the RS485 connection and poll the device for the DHCP IP address by entering:

get<SPACE><Device>:IPD<CR><LF>.

If available, the instrument will submit the DHCP address that can be used in a second step in a web browser to connect to the system.

The user IP-address can be set or queried by the user via RS485 using the parameter IPS instead of IPD, e.g.:

```
get<SPACE><Device>:IPS<CR><LF>
```

For further communication please contact G. Lufft GmbH for assistance.

7.3 Shutting Down

Advanced users shall power off the system carefully to avoid any data loss:

1. Users with software superuser privileges shall use the web interface: login in as superuser and press "SHUTDOWN SYSTEM" at the data transfer panel, the same command is available for the RS485 interface.
2. Service trained persons may also open the inner housing door and press the white "shut down" button at the main controller (check service manual for details)

Procedures (1) or (2) have the same effect. The Linux based system is powered down and measuring data are saved on the local SD Card.

3. Switch off the power supply.

To disassemble the CHM15k Cloud Height Meter and install it in another location, perform the sequence of working steps described in chapter 6.1.2 and chapter 6.2 in reverse order.



NOTE

In case of malfunction/faults, disconnect the CHM 15k from power supply (using the mains circuit breaker). Turn on power again after a short pause. If the problem persists, you should contact a qualified on-site service technician. If case of urgent problems, you should directly contact the service from Lufft.

7.4 Disposal



NOTE

Disposal of the CHM 15k Cloud Height Meter must be in accordance with national regulations.

8 Communication RS485 & Ethernet

The CHM 15k Nimbus supports two interfaces RS485 (section 8.2) and Ethernet (section 8.7) to communicate with the instrument. Both have the opportunity to transfer the measured values and to configure the instrument.

A web-interface is part of the system for the main communication (configuration) over the Ethernet interface. It can be accessed by many web browser independent from the operating system.

The web-interface can also be used to download measured data manually, which are stored in daily NetCDF (section 8.4) files on a build in SD Card. An AFD (ftp) service (section 8.8) is implemented in the system too, which allows the transfer of eg 5 min blocks of NetCDF data to any external ftp server.

For RS 485 communication a terminal software is required. For operating systems running Microsoft Windows™ the terminal software "JO-DataClient" is supplied together with the equipment.

NOTE

The RS 485 half-duplex interface does not allow sending and receiving data on at the same time. Accordingly, the interface has its own automatic switching mechanism. This explains why you cannot send other commands (refer to chapter 8.1) when receiving a data telegram. Data telegrams are described in chapter 8.3.3 to 8.3.5. Incoming initial <STX> and end <EOT> character codes are indication of a running receive transmission session.



CAUTION

Loss of data!

If you use query software other than "JO-DataClient", make sure that it provides an internal function for automatic switching between transmitting and receiving mode. Otherwise, malfunctions may occur at the RS485 interface and cause loss of data.



8.1 List of configurable instrument parameters

Table 3 contains the most important setting options. They will be explained in the following sections. For safety reasons and because they have a considerable influence on the way the CHM 15k functions, some options are only available if the ceilometer is set into a service mode(RS485) or superuser mode (Ethernet). Some additional parameters like the instrument name itself can be set only as service user using a Ethernet connection.

table 4 provides a list of additional read only parameters. These parameters are partly saved on the EEPROM mounted on the laser optical module (LOM). They have an impact on data evaluation and basic system settings. The tables are containing the permissible value range for each parameter together with the default value that is set at the time of product shipment and an indicator if service mode is required or not.

Parameter name	short cmd	standard value	range / short description
AFDmode*	AFD	0	0; 1, switch on, ftp data transfer
Altitude(m)	ALT	0	0 – 9999, unit is always meter!
ApdControlMode*	ACM	3	0 – 3, APD modes, only change if you know how to do
Azimuth	AZT	0	0-360 degree x 100 (handled as integer)
Baud	BAU	3	2 – 7 (4.800 – 115.200 Baud)
BaudAfterError*	BAE	3	2 – 7 (4.800 – 115.200 Baud)
BlowerMode	BLM	0	0 – 4
CHMTest	CHT	0	0; 1
DateTime			DD.MM.YYYY;hh:mm:ss (8.1.6)
DeviceType	DVT	CHM15k	unit type, eg. {CHMxk, PLC,...}
dt(s)	DTS	15	logging & reporting time: 5 – 600 s
DeviceName (old: FabName)*	SRN	CHMyyxxxx	CHM + serial No of the CHM instrument
Gateway	GAT	0.0.0.0	set/ query static gateway address
IgnoreChars*	ICH	06	8Bit-ASCII-Codes
Institution	INS	NN	Any character (text) string
IPAddress	IPS	0.0.0.0	set/ query the static IP address
LATitude	LAT	52.40050 ³ 5240050 ²	-90 to +90 degree decimal value (+ degrees north)
Layer	NOL	3	1 - 9, (JO-DataClient limited to 5)
LaserMode*	LSM	1	0; 1 switch on/ off Laser
Location	LOC	NN	alphanumerical character string (max. 31 characters)
Longitude	LON	13.239050 ³ 13239050 ²	-180 to +180 degree decimal value (+ degrees-east)
MaxCrosstalkChars*	MCC	5	0 – 1024
Netmask	NMA	0.0.0.0	set/ query static netmask address
NtpMode	NTM	1	0; 1 switch on / off ntpd
NtpServer	NTS	0.0.0.0	set/ query NTP time server address
PelTierMode*	PTM	1	0; 1 switch on/ off detector peltier mode
PowerSaveMode	PSM	0	0; 1 (cannot be set in actual firmware)
RangeResolution	RAR	3	Number of 5m range intervals integrated for the NetCDF range vector
RangeStart	RAS	15	first range value in the NetCDF file
RangeEnd	RAE	15345	last range value in the NetCDF file
RangeHRDim	RHD	32	No of data points in the high resolution range vector

Table 3: list of configurable device parameter; *can be set in service mode; ²can be set in the web interface only, ³ can be set in terminal (RS485).

Parameter name	short cmd	standard value	range / short description
Reset	RST	0	0; 1 Reboot of the CHM embedded system (refer to chapter 8.2.4)
ResetSettings ³	RSG	0	0; 1 Reset to factory defaults, refer to chapter 8.2.4, web-interface: set to factory defaults)
ReStartNetwork	RSN	0	0; 1 writes new settings in network configuration file and restarts the network
RS485Number (old: devicenummer)	RNO	16	0 – 99 (used in RS485 chains)
ServiceMOde ³	SMO	0	0; 1 switches to servicemode, to modify „critical“ values.
STandBy	STB	0	0; 1, standby mode with standby telegram, to reduce power consumption
SHuTdown	SHT		0; 1 shutdown CHM system
TimeOutRs485(s)*	TOR	30	5 – 3600
TimeZoneoffsetHours	TZH	0	-12 12 hours, e.g. CET is +1, used to control window blower
TransferMOde	TMO	0	0 – 9
TransferModeafterError*	TME	0	0 – 9
UAPD		1	0 – 500000, set voltage for APD in manual APD modes [mV]
UNiT(m/ft)	UNT	m	m, ft
UseALtitude	UAL	0	0; 1
ZEniTh	ZET	0	0 - 90 degree x 100, 0° := vertical (handled as integer)

Table 3: list of configurable device parameter; *can be set in service mode; ²can be set in the web interface only, ³ can be set in terminal (RS485).

Parameter	Short CMD	Default value	Description
APDBreakdown	UBR	400000	voltage value for comparison [mV]
ApdTempGradient	TCO	2400	value for comparison [$\mu\text{V/K}$]
IPDhcp	IPD		IP address DHCP
LAserPower	LAP	50	laser power value for comparison
LifeTime(h)	LIT	xxxxxxx	# of hours the laser diode is in operation
Parameters			delivers a list of all parameters available in RS 485 mode
serLOM	LOM	TUByyxxxx	serial number of laser optical module (LOM)
SystemLifeTime(h)	SLT		Total running hours of the CHM system
TBCalibration	TBC		scaling factor against reference
VersionFPGA	VFP		firmware FPGA
VersionFirmware	VFI		firmware version (data processing and handling)
VersionLinux	VLI		Linux Kernel Version

Table 4: Read only parameters, accessible via RS485 interface

Explanatory notes relating to table 3

AFDMode: Switch on/ off the advanced file distribution system via LAN / WAN/ DSL, see <http://www.dwd.de/AFD/> for further information or section 8.8.

Altitude(m): Indicates altitude of measurement location above sea level (in meters). In NetCDF files the parameter CHO (cloud base offset) is used. It logical combines the variables altitude and usealtitude.

Azimuth: Indicates horizontal angle (in degrees)

Baud: For changes in baud rate (refer to chapter 8.2.3).

BaudAfterError: Standard baud rate after communication error (refer to chapter 8.2.3)

BlowerMode: Used to test the window blower and to set them into different operation modes. For example: quiet during night. The parameter „Time Zone offset Hours“ must be set correctly, because the system itself operates in UTC time. 0 = hourly and weather-dependent, 1 = no hourly from 22 to 6 o'clock, 2 = off from 22 to 6 o'clock, 3 = always on, 4 = always off

DateTime: Set date and time (refer to chapter)

dt(s): logging time (in automatic more identical to reporting time)
 A decrease in time resolution (corresponding to an increase in dt) will cause more photon pulses (shots) to be averaged over time and yields an improvement in signal-to-noise performance. An increase by a factor of n results in an improvement by a factor of the root of n. All raw data which is found to be within a given time window dt(s) will be involved in evaluation. There is no single data selection option available.

DeviceName/ FabName: The product designation (CHM) combined with serial

number of a given device, e.g. CHM060001.

IgnoreChars: Variable contains 8Bit-ASCII-codes will be ignored by the CHM 15k. The ASCII-codes have to be coded as 2 character HEX-code, e.g. "06" corresponds to <ack>. Only HEX-codes will be evaluated!

Institution: The name of the institution or company

Lasermode:

LaserPower: Laser Power in mW

Latitude: The latitude of a given location, in decimal numbers.

Sample value for Berlin: 52.51833 (corresponds 52° 31' 6" N)

Layer (Number of Layer): No. of cloud layers displayed in extended telegram and NetCDF file

Layer: set the number of layers in the cloud telegram.

Lifetime(h): For querying of operating counter state of the laser lifetime.

Location: Set/ query the location, where the instrument is used. The name is restricted

Longitude: The longitude of a given location, in decimal numbers, where east-erly is defined as positive orientation.

Sample value for Berlin: 13.40833 (corresponds to 13° 24' 30" E)

MaxCrossTalkChars: Sets a Number of characters the CHM 15k will ignore within "TimeOutRS485(s)" if they are received in a fragmentary string, which may be a query not ended with <EOT> (04 HEX), <CR> (0D HEX), <LF> (0A HEX). The parameter is included to prevent the ceilometer to fall back in its standard baud rate caused by noise on unstable communication lines.

Parameters: For querying of a complete parameter list (see Annex B for details)

RS485Number: Designates the identification number in a bus system, which is required to address a given device via a data port.

Standby: Turns off laser, heater and blower

TimeOutRS485(s): Set time interval within MaxCrossTalkChars and BaudAfterError is reacting (standard 30s).

TransferMode: Refer to chapter 8.3.1 to 8.3.5.

Unit(m/ft): sets dimensions in meters (m) or feet (ft).

UseAltitude: Adds Altitude(m) to data output string.

If a value of e.g. 60 m is specified for Altitude, the output value for a given cloud base will increase by 60 m.

Zenith: Indicates vertical angle (in degrees), the sky condition algorithm (SCA) is using this angle to calculate the real altitude of cloud bases against ground level.

8.2 Instrument Configuration using RS 485 interface

The user can change settings via the RS485 interface for:

- control of the measuring process
- configuration of the communication interfaces

8.2.1 Reading a parameter

To read a parameter, you must trigger a command:

get<SPACE><RS485No>:<ParameterName><CR><LF>

If <ParameterName> is found to contain a valid designation according to table 3 or table 4, its value will be output as part of

<STX>get<SPACE><RS485No>:<ParameterName>=<Value>;<ASCII-Two's complement><CR><LF><EOT>

Example:

If the instrument serial number (Devicename) was preset to CHM060003, you may query the name, using the short command

get 16:DVN<CR><LF>

The response to this query may look like this:

<STX>get 16:DeviceName=CHM15kd01;2B<CR><LF><EOT>.

where each of <STX>, <CR>, <LF> and <EOT> stand for one byte with hexadecimal codes 02, 0D, 0A and 04 in this same order. The value 3F represents the checksum of the two's complement formed over the whole response line, excluding the two characters (3F) themselves, in accordance with the established protocol response format (refer to chapter 8.3.3 to 8.3.5).

8.2.2 Setting a parameter

A command line like

set<SPACE><RS485No>:<ParameterName>=<Value><CR><LF>

can change a desired configuration parameter. The successful completion of a change in parameter setting is reported via:

<STX>set<SPACE><RS485No>:<ParameterName>=<Value>;<ASCII-Two's complement><CR><LF><EOT>

If <Value> is found to be within permissible limits, the newly set value <NewValue> meets this requirement. If an entry is found to be above the upper limit or below the lower limit, the permitted maximum or minimum value will be applied instead. With alphanumerical entries the default value will be applied as <Value>.

Example:

Following a command,

set 16:Unit(m/ft)=ft<CR><LF>

or in short form

set 16:UNT=ft<CR><LF>

all range data in a telegram will be indicated in feet (ft) instead of meter (m).

Since **Unit(m/ft)** provides a switching option,

<STX>set 16:Unit(m/ft)=ft;2A<CR><LF><EOT>

is output for confirmation. 2A is the checksum value of the response line.

8.2.3 Change in Baud Rate

Changes in the baud rate are a special setting option. To make a change, proceed as described in chapter 8.2.2. For example, by triggering a

set<SPACE>16:Baud=4<CR><LF>

command, you will set baud rate "4", i.e. 19,200 bits per second, for RS485No 16. Table 5 shows all baud rate numbers and their assigned baud rate values.

Baud rate no.	Baud rate [bits/s]
(0)	(1,200)
(1)	(2,400)
2	4,800
3	9,600
4	19,200
5	38,400
6	57,600
7	115,200

Table 5: Baud-rate-number-to-baud-rate assignments. Baud rates 0;1 are not specified within the time limits.

Immediately on triggering a set command of this type, the interface will be set to

the new baud rate. In the event of a false baud rate setting with consequential communication errors, it is not possible to reverse this setting as usual because of failure to establish normal communication. It will be reset to the default baud rate specified by parameter **BaudAfterError** after 30 seconds, which is the standard value of **TimeOutRS485(s)**. The standard value of BaudAfterError is 3 (refer to chapter Table 3:) which means 9,600 bits per second. If this baud rate still proves too high, a different desired baud rate can be set as the default rate before product shipment or by service personnel.

8.2.4 Reboot of embedded linux system/ reset to factory settings

By triggering a

set<SPACE>16:Reset=1<CR><LF>

command, the build in processor board is instructed to immediately perform a reboot.

A restart procedure takes less than a minute. Before or unless it has finished, communication with the CHM 15k is not possible. The same applies to continuously ongoing telegram outputs.

With a

set<SPACE>16:ResetSettings=1<CR><LF>

command you can restore all parameters to their factory settings.

8.2.5 Changing the logging time dt(s), date & time

set<SPACE><RS485No>:dt(s)=30<CR><LF>

The logging and reporting time is set to 30s. The internal measurement time is always set to 1s. The logging and reporting time must be multiple of one second.

With the help of

set<SPACE>16:DateTime=DD.MM.YYYY;hh:mm:ss<CR><LF>

you can switch the date and time settings of the internal processing unit, where DD means day, MM month, YYYY year, hh hours, mm minutes and ss seconds, referenced to GMT zone (Greenwich Mean Time).

Example:

set 16:DateTime=13.04.2006;17:22:46<CR><LF>

will set 13th April 2006 as the date and 17:22:46 GMT as the exact time.



The terminal software JO-DataClient has a build in update function for the time called „-utcupdaterate <hours>“ (chapter 11.10). If the ceilometer is connected to a WAN or LAN and the NTP option is active, time settings over the serial interfaces shall be avoided.

8.3 Data Queries RS485

At any time during operation, the CHM 15k is in one of the following transfer modes as shown in table 6.

Transfer mode	Meaning
0	Data telegrams are output on special request
1	Automatic output of standard data telegram
2	Automatic output of extended data telegram
3	Automatic output of raw data telegram
4...	Automatic output of user specified data telegrams (available vis Ethernet interface and web interface)

Table 6: Summary table of transfer modes

Changes in transfer mode can be made with the help of set commands as described in chapter 8.2.2 or by using the web interface.

For example:

set<SPACE>16:TransferMode=1<CR><LF>

will activate the standard transfer mode (automatic output of standard data telegram) that had been factory-set before shipment of the device.

8.3.1 Polling Mode

The command

set<SPACE><RS485No>:TransferMode=0<CR><LF>

will turn on polling mode, while turning off automatic telegram output mode which may have been active until that moment. The following three commands

get<SPACE><RS485No>:S<CR><LF>

get<SPACE><RS485No>:L<CR><LF>

get<SPACE><RS485No>:A<CR><LF>

can now be used for a single standard telegram (**S**), a single extended data telegram (**L**) or a single raw data telegram (**A**) polling action. Refer to data telegram description parts in refer to chapter 8.3.3 to 8.3.5 (table 7, 8, 10) for format information.

NOTE

The new hardware platform of the CHM15k Nimbus does support additional user telegrams. In addition to the characters {S, L, A}, numbers are supported, too. With S=1, L=2, A=3 the first numbers are predefined. The telegram 4 is a system dependent telegram from Lufft. Telegram numbers 5 to 9 can be defined by user.



8.3.2 Automatic Output Mode

The command

set<SPACE><RS485No>:TransferMode=1<CR><LF>

will turn on automatic mode with the standard telegram output. Its repetition

rate depends on the content of variable dt(s) which is set to 30 seconds by default.

table 7 contains the format of standard data telegrams

For extended data telegram output use the command:

set<SPACE><RS485No>:TransferMode=2<CR><LF>

table 8 contains the format of extended data telegrams.

The output of the raw data plus extended data telegram will be received using the command:

set<SPACE><RS485No>:TransferMode=3<CR><LF>

table 10 contains the additional format structure of raw data telegrams.



NOTE

Transfermode=4, ..., 9 are additional telegrams, which are system dependent or defined by the user.

8.3.3 Standard Data Telegram

The standard data telegram consists of 96 Bytes. Data are separated with spaces (20 HEX). Table 7 shows the exact structure of the message format.

Byte	Value ¹	Description
0	<STX>	02 HEX
1	X	
2	1	
3, 4	TA	
5	<SPACE>	20 HEX
6	8	
7	<SPACE>	20 HEX
8-10	***	Output interval [s]
11	<SPACE>	20 HEX
12-19	**.**.**	Date (dd.mm.yy)
20	<SPACE>	20 HEX
21-25	**.**	Time (hh:mm)
26	<SPACE>	20 HEX
27-31	*****	1 st cloud layer
32	<SPACE>	20 HEX
33-37	*****	2 nd cloud layer
38	<SPACE>	20 HEX
39-43	*****	3 rd cloud layer
44	<SPACE>	20 HEX
45-48	****	Laser beam penetration depth into 1 st cloud layer
49	<SPACE>	20 HEX

Table 7: Standard data telegram format, ¹(*) = any character

Byte	Value ¹	Description
50-53	****	Laser beam penetration depth into 2 nd cloud layer
54	<SPACE>	20 HEX
55-58	****	Laser beam penetration depth into 3 rd cloud layer
59	<SPACE>	20 HEX
60-64	*****	Vertical visibility
65	<SPACE>	20 HEX
66-70	*****	Maximum detection range
71	<SPACE>	20 HEX
72-75	****	Cloud height offset/ parameter altitude(m)
76	<SPACE>	20 HEX
77, 78	Ft/m<SPACE>	Unit of measure (ft/m)
79	<SPACE>	20 HEX
80, 81	**	Precipitation index
82	<SPACE>	20 HEX
83-90	*****	System status and messages (flags may take on "0" or "1" state)
91	<SPACE>	20 HEX
92, 93	**	Checksum (two's complement of the sum of bytes 0 to 96, excluding bytes 92 and 93, expressed in hex code)
94	<CR>	0D HEX
95	<LF>	0A HEX
96	<EOT>	04 HEX

Table 7: Standard data telegram format, ¹(*) = any character

A maximum of three cloud heights can be indicated. If less than three cloud heights were detected, a "NODET" message will appear in the remaining field(s). Missing cloud penetration depths will be reported through a "NODT" in the standard telegram message caused by the limited field size.

The fields:

- Cloud height
- Cloud penetration depth/Cloud thickness
- Visibility
- Maximum detection range

will show a "NODET" value too, whenever the algorithm is not able to calculate these values. The same fields will carry a "-" minus sign if their values cannot be established because of a device error. For detailed information on device error types, you should refer to the service codes table (refer to chapter 8.5).

In general, the cloud height shall be measured from the unit base. If the parameter "altitude(m)" is set to a nonzero value and "usealtitude" is set to 1 the cloud height is corrected by this factor. In NetCDF files the variable CHO indicates whether usealtitude is set or not.



8.3.4 Extended Data Telegram

The extended data telegram consists of 240 Bytes. Semicolon (3B HEX) replaces space (20 HEX) as delimiter for extended data telegrams. Table 7 shows details about the telegram structure. **The telegram size is different if the number of cloud layers “layer” has been changed.**

Byte	Value ¹	Description
0	<STX>	20 HEX
1	X	
2	1	
3	TA	
5	;	20 HEX
6	8	
7	;	20 HEX
8	***	Output interval [s]
11	;	20 HEX
12	**.*.*	Date (dd.mm.yy)
20	;	20 HEX
21	**.*.*	Time; Note modification, as of now (hh:mm:ss)
29	;	20 HEX
30	*	Numbers of layer
31	;	
32	*****	1 st Cloud layer (CBH)
37	;	20 HEX
38	*****	2 nd Cloud layer (CBH)
43	;	20 HEX
44	*****	3 rd Cloud layer (CBH)
49	;	20 HEX
50	*****	Penetration depth of the laser beam into the 1 st cloud layer (CPD), Note: extension to 5 digit
55	;	20 HEX
56	*****	Penetration depth of the laser beam into the 2 nd cloud layer (CPD), Note: extension to 5 digit
61	;	20 HEX
62	*****	Penetration depth of the laser beam into the 3 rd cloud layer (CPD), Note: extension to 5 digit
67	;	20 HEX
68	*****	Vertical visibility (VOR)
73	;	20 HEX
74	*****	Max. detection range (MXD)
79	;	20 HEX
80	****	Cloud height-Offset / altitude(m)
84	;	20 HEX

Table 8: Format of extended data telegrams (also refer to Table 9), ¹ * = any character

Byte	Value ¹	Description
85	m	unit of measurement in m or ft
87	;	20 HEX
88	**	Precipitation index/ Sky Condition Index (SCI)
90	;	20 HEX
91	*****	System status, 32 Bit Service code, so far 157-164
99	;	20 HEX
100	**	RS485 identification number of CHM 15k in RS485 bus systems, default is 16
102	;	3B HEX
103	CHMyynnnn	Device name (FabName) (yy for year, nnnn for consecutive number)
112	;	3B HEX
113	****	Standard deviation 1 st cloud layer (CBE)
118	;	3B HEX
119	****	Standard deviation 2 nd cloud layer (CBE)
124	;	3B HEX
125	****	Standard deviation 3 rd cloud layer (CBE)
130	;	3B HEX
131	****	Standard deviation penetration depth of the laser beam into the 1 st cloud layer (CDE)
135	;	3B HEX
136	****	Standard deviation penetration depth of the laser beam into the 2 nd cloud layer (CDE)
140	;	3B HEX
141	****	Standard deviation penetration depth of the laser beam into the 3 rd cloud layer (CDE)
145	;	3B HEX
146	*****	Standard deviation vertical visibility (VOE)
151	;	3B HEX
152	****	Software-Version FPGA
156	;	3B HEX
157	****	Software-Version Firmware OMAP
161	;	3B HEX
162	**	System status: "OK" or "ER"
164	;	3B HEX
165	****	Outer temperature (Kelvin x 10)
169	;	3B HEX
170	****	Inner temperature (Kelvin x 10)
174	;	3B HEX
175	****	Detector temperature (Kelvin x 10)
179	;	3B HEX
180	****	NN1
184	;	3B HEX
185	****	NN2

Table 8: Format of extended data telegrams (also refer to Table 9), ¹ * = any character

Byte	Value ¹	Description
189	;	3B HEX
190	*****	Laser operating time (h)
196	;	3B HEX
197	***	Status Window
200	;	3B HEX
201	*****	repetition rate of the laser (PRF) (5 digit)
206	;	3B HEX
207	***	Status receiver
210	;	3B HEX
211	***	Status light source
214	;	3B HEX
215	*****	Aerosol layer 1
220	;	3B HEX
221	*****	Aerosol layer 2
226	;	3B HEX
227	*	Quality index Aerosol layer 1 Byte
228	;	3B HEX
229	*	Quality index Aerosol layer 1 Byte
230	;	3B HEX
231	*	BCC, base cloud cover
232	;	3B HEX
233	*	TCC, total cloud cover
234	;	3B HEX
235	**	Checksum (two's complement of the sum of bytes 0 -239, expressed in hex code exclusive of 235 and 236)
237	<CR>	0D HEX
238	<LF>	0A HEX
239	<EOT>	04 HEX

Table 8: Format of extended data telegrams (also refer to Table 9), ¹ * = any character

For standard deviations quoted above, the same exceptional "NODET/NODT/NaN/---" values are valid as for the corresponding reference parameters (refer to chapter 8.3.3).

NOTE



For explanations regarding system parameters involved in data evaluation, such as penetration depth, refer to chapter 9

Term	Explanatory note
External temperature	The outer temperature measured at the CHM's bottom face. For precise measurement of outer temperature, an error of ±5 °C is permissible. Readings are displayed in Kelvin x 10.

Table 9: Terms in extended data telegram

Inner temperature	Temperature measured at the sensor: displayed in Kelvin x 10; ±2 K
Detector temperature	Temperature measured at the sensor: displayed in Kelvin x 10; ±2 K
NN1	unassigned
NN2	unassigned
Laser operating time (h)	Laser lifetime hours of operation
Optics status	Degree of contamination of glass panel in percent 100 = transparent, 0 = opaque
Laser pulse number	Number of laser pulses in logging interval (7-digit)
Receiver status	For tracking of optical beam path and receiver status. 100 = maximal sensitivity 0 = sensitivity down to zero
Light source status	Evaluates lifetime and stability of the laser light source temperature, current stability, repetition rate; 100% = starting value, <20 = laser switches off

Table 9: Terms in extended data telegram

8.3.5 Raw Data Telegram

Raw data are output in NetCDF-format that is explained in chapter 8.4. NetCDF is a binary format. For transfer via RS485/ RS232 it has to be converted into 7-bit ASCII code (21 to 60 HEX range) using UUencode to be able to handle special characters like <STX> or <EOT>.

The NetCDF-file of a raw data set is about 14 kByte long. UUencode transformation turns these into 20 kB of ASCII data that need to be transmitted. With a baud rate setting of 9.6 kbps =1.2 kbps), transmission takes about 16 seconds, which results in the following additional restrictions on automatic raw data telegram outputs as shown in table 10.

Baud rate no.	Baud rate [kbps]	logging time interval (dt(s))
0	1.2	Not available
1	2.4	Not available
2	4,800	≥ 40 s
3	9,600	≥ 20 s
4	19,200	≥ 10 s
5	38,400	≥ 5 s
6	57,600	No further restrictions
7	115,200	No further restrictions

Table 10: Additional restrictions

Table 11 describes the structure of additional data in a raw data telegram.

Byte	Value ¹	Description
0-238		Same as in extended data telegram (for 3 cloud layers)
239	<CR>	0D HEX
240	<LF>	0A HEX
241-(eeee-5)		Raw data in ASCII format (UUencode)
eeee-4 eeee-3	**	Checksum (two's complement of the sum of bytes 0 to eeee, excluding bytes eeee-4 and eeee-3, expressed in hex code)
eeee-2	<CR>	0D HEX
eeee-1	<LF>	0A HEX
eeee	<EOT>	04 HEX

Table 11: Raw data telegram format

1 * =any character

According to the UUencode standard, lines containing raw data are organized as follows:

1st line:

begin 644 YYYYMMDDhhmmss_[location]_[device].nc<CR><LF>

2nd line:

M*****<CR><LF>

3rd line:

M*****<CR><LF>

...

(n-2)th line:

M*****<CR><LF>

(n-1)th line:

E***** **<CR><LF>

nth line:

end<CR><LF>

* stands for any UUencode character that falls within the hex range HEX 21 to 60.

"M" (HEX 4D) at the beginning of a data line designates the number of data bytes in this line, equally UUencoded:

- 4D, when decoded, corresponds to the number HEX 2D = 45 decimal.

By 4/3-UUencode conversion, these 45 bytes are encoded in 60 (60=45/3 x 4) ASCII characters following "M", except for the last line where only the last bytes, typically less than 45, are encoded.

The example above contains "E" (HEX 45, HEX 25=37 decimal, decoded) which means that 37 bytes of raw data are following. As a consequence of 4/3-encoding (rounded up to a multiple of four), however, they require 52 (52=(37/3 rounded) x 4) ASCII characters.

The last line with "end" marks the termination of UUencode data.

An example of a file name in line 1

YYYYMMDDhhmmss_ [location]_[Device].nc

is 20060331123730_Jena_CHM06003.nc (also refer to chapter 8.4.3).

which means:

- CHM060003 fabrication number in Jena, data of 31st March 2006, at 12:37:30.

If the device e. g. by means of an angle adapter placed obliquely, so does in line 1 the file name changes as follows:

YYYYMMDDhhmmss_ [location]_[zenith]_[Device].nc

In [zenith], the appropriate number of degrees is entered, for example 15°.

8.3.6 User configured data telegrams

The structure of data telegrams are defined in a file called "telegram.xml". It can be downloaded and modified using the web interface in the superuser or service user mode.

8.4 NetCDF Format Structure

8.4.1 General

The Cloud Height Meter saves all measured backscatter profiles in a day file of NetCDF format (**Network Common Data File**). Its storage capacity allows the files to be kept on record for approximately one month. In a “Communication interrupted” service case, affected data can be inspected and traced back. The raw data of a single measurement can be called up as a raw data telegram via the RS485 interface. Standard operation does not include the transmission of a day file, since this would negatively influence the time sequencing in this mode. Because the transmission rate depends on the time resolution of the measured data and the RS485 interface settings, this transmission would take too long. An one day NetCDF file with dt(s)=30s measurement time intervals will be approximately 11 MB in size. Switching to 15s time resolution 22 MB file sizes are generated. In service cases, a transmission of the NetCDF file is possible (direct connection to Cloud Height Meter via RS485 or Ethernet) (refer to Service Manual).

8.4.2 Fundamentals

NetCDF provides a computer-platform-independent interface for the saving and reading of scientific data. It was developed under Unidata, a project funded by the National Science Foundation (<http://www.unidata.ucar.edu>). Each data set contains an explanation of its storage content.

The ceilometer saves all data from a single day in a file, using UTC as the time base. In serial mode (RS485) the CHM 15k transmits a raw data telegram with a single backscatter profile and any related descriptive variables and attributes in NetCDF format. The raw data daily telegrams may, in turn, be summarised in a day file. The “JO-DataClient” software will generate the day files automatically.

8.4.3 File Names

Daily NetCDF file:	YYYYMMDD_[location]_[Device].nc
Raw data in RS485 telegram 24h:	YYYYMMDDhhmmss_[location]_[Device].nc
Raw data 24h at web-interface:	YYYYMMDDhhmmss_[location]_[Device]_Index.nc
Raw data with other time resolution, eg. for ftp mode (AFD):	YYYYMMDDhhmmss_[location]_[Device]_hmm-Index.nc



NOTE

For fail-safe transmission of files, ISO standard requirements must be observed in their extended version, i.e. the length of a file name must not exceed 31 characters. In terms of the setup of a day file with [Date]_[location]_[Device-ID].nc (8_9_9.2=31 characters) this implies that the “location” name must not be longer than 9 characters.

8.4.4 Format Structure

Value saved in NetCDF format can be dimensions, variables and attributes. table 12 to 14 describe the various terms.

Dimensions

Dimension	Description
time	The number of backscatter profiles inside the NetCDF file
range	The number of bins measured and stored in backscatter profiles in NetCDF format with 15m resolution.
range_hr	The number of bins stored in NetCDF backscatter profiles with 5 m resolution.
layer	The number of cloud layer transmitted in telegrams and stored in NetCDF files.

Table 12: Dimensions in NetCDF

Variables

Variable	Description
float latitude units = "degrees_north" long_name = "latitude of location"	latitude of the measurement location, decimal value -90° to +90° Example: Jena = 50.93333 corresponding to: 50°56'0" N
float longitude units = "degrees_east" long_name = "longitude of location"	The longitude of the measurement installation, decimal Example: Jena = 11.58333 corresponding to: 11°35'0" E
float time (time) units = "seconds since YYYY-MM-DD 00:00:00 00:00" long_name = "time UTC" axis = "t"	End time of measurement Allows for accuracy of 0.007 seconds
float range units = "m" long_name = "distance from lidar" axis = "range"	The distance from the CHM 15k in meter, independently of altitude of the instrument location.
float range_hr units = "m" long_name = "high resolution distance from lidar" axis = "range_hr"	The distance from the CHM 15k in meter, independently of altitude of the instrument location.
float altitude units = "m" long_name = "altitude of ceilometer above mean sea level"	The altitude of the measurement location above sea level.

Table 13: Variables in NetCDF

float azimuth units = "degree_clockwise" long_name = "laser direction of site"	The azimuth angle of the pointing direction of the laser on site.
float zenith units = "degree" long_name = "laser direction of site"	The zenith angle of the pointing direction of the laser on site. Used if an tilting adapter plate is used for 5 or 15 degrees.
float wavelength units = "nm" long_name = "laser wavelength"	The laser wavelength in nm here: 1064
int laser_pulses (time) long_name = "number of laser pulses per record (lp)" units = "unitless"	The number of laser pulses averaged in one measurement.
float range_gate long_name = "length of range gate, bin-width" units = "m"	The spatial resolution of measurement.
int average_time(time) long_name = "average time per record" units = "ms"	The time over which averaging is performed.
float beta_raw(time, range) units = "unitless" long_name = "normalized range corrected signal ((signal_raw/ lp)-b)/(c* o(r)*p_cal)*r ² "	Lidar backscatter raw data with ≈ 15 m resolution, normalized and range corrected. lp: laser pulses, b: baseline, c: scaling, o(r): overlap function, p_cal: calibration signal
float beta_raw_hr(time, range_hr) units = "unitless" long_name = "normalized range corrected signal ((signal_raw/ lp)-b)/(c* o(r)*p_cal)*r ² "	Lidar backscatter with ≈ 5 m resolution, raw data normalized and range corrected.
int error_ext (time) long_name = "31 Bit ServiceCode" units = "unitless"	Standard status bit sequence Service codes described n chapter 8.5
short state_optics (time) long_name = "transmission of optics" units = "percent"	Optics quality index in percent
short temp_int (time) long_name = "internal temperature in K*10" units = "K" scale_factor = 10	Inner casing temperature [Kelvin x 10]
short temp_ext (time) long_name = "external temperature in K*10" units = "K" scale_factor = 10	Outer casing temperature [Kelvin x 10]
short temp_det (time) long_name = "detector temperature in K*10" units = "K" scale_factor = 10	Detector temperature [Kelvin x 10]

Table 13: Variables in NetCDF

short temp_lom (time) long_name = "laser optic module temperature in K*10" units = "K" scale_factor = 10	Laser optic module temperature [Kelvin x 10].
int life_time (time) long_name = "laser life time" units = "h"	Laser operating time in hours.
short state_laser (time) long_name = "laser quality index" units = "percent"	Laser quality index in percent.
short state_detector (time) long_name = "quality of detector signal" units = "percent"	Detector quality signal in percent.
float base (time) long_name = "baseline raw signal in photons per shot (b)" units = "counts / shot"	Baseline height of the raw signal mainly influenced by daylight. Transmitted in photons per shot.
float stddev (time) long_name = "standard deviation raw signal in photons per shot " units = "counts / shot"	Standard Deviation of the raw signal, in photons/ shot
short p_calc (time) long_name = "calibration pulse in photons per shot" units = "counts / shot" scale_factor="100000"	Calibration pulse used to normalize individual units over time.
float scaling units = "unitless" long_name = "scaling factor (c)"	Scaling factor used to normalize individual units against reference system. (called TBcalibration in RS485).
short nn1 ... nn3	used by manufacturer
short PBL (time, layer) long_name = "aerosol layer in PBL" units = "m" axis="range"	Aerosol layer calculated within the planetary boundary layer.
schar PBS (time, layer) long_name = "quality score for aerosol layer in PBL" units="unitless"	Quality score for aerosol layers.
schar SCI (time) long_name = "sky condition index"	sky condition index
schar BCC (time) long_name = "base cloud cover" unit="eighths"	base cloud cover
schar TCC (time) long_name = "total cloud cover" unit="eighths"	total cloud cover
short CBH (time, layer) long_name = "cloud base height" unit="m" axis="range"	cloud base height

Table 13: Variables in NetCDF

short CBE (time, layer) long_name = "cloud base uncertainty" unit="m"	cloud base uncertainty
short CDP(time, layer) long_name = "cloud penetration depth" unit="m" axis="range"	cloud penetration depth
short CDE (time, layer) long_name = "cloud penetration depth uncertainty" unit="m"	cloud penetration depth uncertainty
short MXD (time) long_name = "maximum detection range" unit="m"	maximum detection range
short VOR (time) long_name = "vertical optical range (VOR)" unit="m"	vertical optical range
short VOE long_name = "VOR uncertainty" unit="m"	vertical optical range uncertainty
short CHO long_name="cloud height offset" unit="m"	cloud height offset (available if, altitude(m) is set and usealtitude=1)

Table 13: Variables in NetCDF

Global Attributes

Attribute	Description
short day	The day of a month, on which the data was recorded
short month	The month, in which the data was recorded, for example, January = 1
short year	The year, in which the data was recorded
text location	Location/ site of measurement
text title	Heading for graphical representation, e.g. "Lindenberg 1064 nm Cloud Height Meter, CHM 15k"
text devicename	Serial number, device name of the instrument
text source	see devicename (left for historical reasons)
text institution	Institution or company
text software_version	Linux kernal, FPGA software, Firmware
text comment	Descriptive comment
text SerLOM	Serial number of LOM

Table 14: Global attributes in NetCDF

8.5 Service Codes

Table 15 explains the meaning of each bit in a 31-bit service code string. The 31-bit service code string is contained in characters 83 to 90 (91 to 99) of the standard (extended) data telegram and in the raw data telegram as an eight-digit hexadecimal number (table 8 and 11). A bit in unset state means that the corresponding part works properly. A bit in set state suggests an error/ warning or indicates that initialization is still underway, e. g. shortly after turning power on.

Bit	HEX code	Description
0	00000001	Error: Signal quality
1	00000002	Error: Signal recording
2	00000004	Error: Signal values null or void
3	00000008	Error: Signal recording error channel 2 (not used for Nimbus)
4	00000010	Error: Create new NetCDF file
5	00000020	Error: Write / add to NetCDF
6	00000040	Error: RS485 telegram can not be generated, transmitted
7	00000080	Error: Mount SD card faile (test: write to raw buffer)
8	00000100	Error: Detector high voltage control failed / cable defect or absent
9	00000200	Error: Inner housing temperature out of range
10	00000400	Error: Laser optical unit temperature error
11	00000800	Error: Laser trigger not detected
12	00001000	Warning: Laser driver board temperature
13	00002000	Error: Laser interlock
14	00004000	Error: Laser head temperature
15	00008000	Warning: Replace Laser - ageing
16	00010000	Warning: Signal quality – low signal/ noise level
17	00020000	Warning: Windows contaminated
18	00040000	Warning: Signal processing
19	00080000	Warning: Max. detection range can not be determined
20	00100000	Warning: File system, fsck repaired bad sectors
21	00200000	Warning: RS485 baud rate/ transfer mode reset
22	00400000	Warning: AFD
23	00800000	Warning: configuration problem
24	01000000	Warning: Laser optical unit temperature
25	02000000	Warning: External temperature
26	04000000	Warning: Detector temperature out of range
27	08000000	Warning: General laser issue
28	10000000	Note: NOL > 3 and standard telegram selected
29	20000000	Note: Power save mode on
30	40000000	Note: Standby mode on

Table 15: Service codes/ status bits

Bits are unassigned and set to "0" by default. Accordingly, a hexadecimal service code "0" indicates that the CHM 15k is fully operational.

8.6 Firmware Update

The CHM 15k Nimbus system can be updated via Ethernet interface (WAN/ LAN connection). Please check the web browser section below for details. A superuser password is needed to perform such an update.

The original update service via the RS485 interface is no longer available.

8.7 Communication via Ethernet - Web-Interface

The communication with the CHM 15k Nimbus using the Ethernet connection is a fast, secure and system independent way. Inside the instrument runs an Apache web server. It enables a communication and configuration platform via web interface to handle firmware updates, quick views of measuring results or downloading full day NetCDF raw data files.

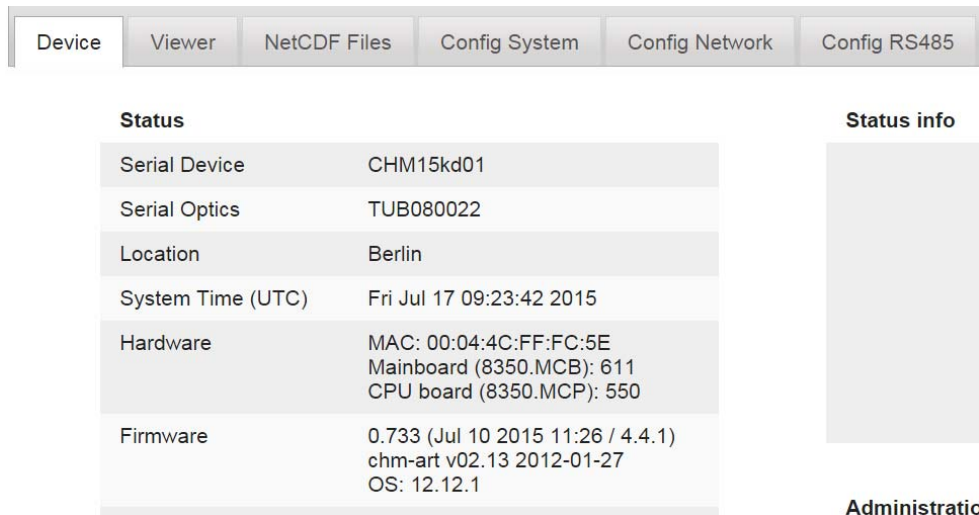

Fig. 12: Web interface device menu in standard user mode. The field is displayed as the first, and shows status information. A login as superuser or service user is available.

Figure 12 shows the start screen after a successful connection to the instrument (start-up procedure in section 7.2).

In general the web interface does include the following right management:

- End-user can check the state of the instrument.
- Super user can additionally download NetCDF files, configure the instrument, download user manual and further configuration files.
- Service user can update the firmware, set the instrument serial number, download the service manual and upload configuration files.

By entering a password in the "Administration" form field, downloadable and configurable elements are enabled, e.g. the IP network configuration (Fig. 15).

The status info on device panel and the process warning panel are displaying warnings and errors updated once a minute. Listed codes in the status info are corresponding to service codes in table 15. The process warning panel (figure 20) contains more details for service people.

In super user or service mode the device panel contains buttons to switch off or restart the system.

Figure 13 shows the NetCDF files panel. NetCDF files can be selected and downloaded, which is visible for all users.

Device		Viewer	NetCDF Files	Config System	Config Net
Count: 7		Update List			
File Name	Size [kB]				
20111213 Teltow CHM15kc02_006.nc	3446				
20111213 www CHM15kc02_005.nc	13				
20111213 Teltow CHM15kc02_004.nc	21				
20111213 Teltows CHM15kc02_003.nc	13				
20111213 Teltow CHM15kc02_002.nc	13				
20111213 Teltow CHMttt_001.nc	21				
20111213 Teltow CHM15kc02_000.nc	87				
		Update List			

Fig. 13: Web interface NetCDF files (superuser): Displays a list of NetCDF files stored on the internal SD Card. NetCDF files can be downloaded by double-clicking in superuser or service mode.

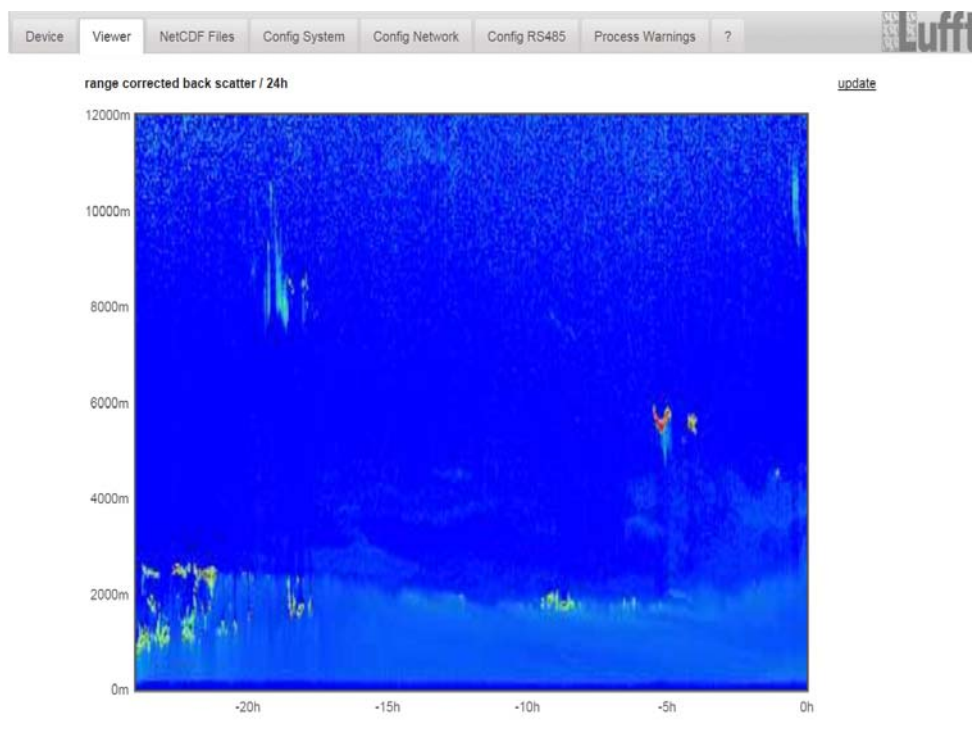

Fig. 14: Web interface/ viewer tab: It shows the last 24h of present data. Press update to renew the pictures file. The “BackscatterMax” parameter in the config system tab (figure 17) can be changed to adjust the colour scale slightly.

The screenshot shows a web interface for network configuration. At the top, there are navigation tabs: Device, Viewer, NetCDF Files, Config System, Config Network (selected), Config RS485, Process Warnings, and a help icon. The main content is divided into three sections:

- Network Information:** A table listing network interfaces and their configurations.

Name	Address	Netmask
eth0 (dhcp)	192.168.150.148	255.255.255.0
eth0:1 (fix)	192.168.100.101	255.255.255.0
eth0:2	192.168.150.200	255.255.255.0
- Network Configuration:** A form for setting network parameters.

IPAddress	192.168.150.200	<input type="text"/>	set
Netmask	255.255.255.0	<input type="text"/>	set
Gateway	192.168.150.1	<input type="text"/>	set

[restart network](#)
- AFD Configuration:** A form for AFD settings.

AfdMode	1	<input type="text"/>	set
---------	---	----------------------	---------------------

[Download AFD dir_config](#)

Upload new AFD dir_config:
 Keine ausgewählt

Fig. 15: Web interface network configuration panel (service mode). The static IP address, netmask and gateway can be changed to local network conditions. To save the settings in the Linux network configuration file and to use the new network settings the network has to be restarted.

The configuration panels in Fig. 15 to Fig. 19 are accessible for superuser or ser-

The screenshot shows the same web interface as Fig. 15, but in standard (read-only) mode. The navigation tabs are the same. The 'Network Information' table is identical. However, the 'Network Configuration' section only displays the current values without the input fields or 'set' buttons. The 'AFD Configuration' section is also present but lacks the 'set' button.

Fig. 16: Web interface config network in standard (read only) mode.

vice engineers. The different parameters are similar to those described in the sub-sections like in the RS485 configuration section in chapter 8.1. Before switching on the AFD mode, its configuration file has to setup carefully (section 8.8). Figure 16 shows just the information of figure 15, which can be seen by any user.

Parameter	current Value	new Value	
DeviceName	CHM15kd01	<input type="text"/>	set
Location	Berlin	<input type="text"/>	set
Institution	Lufft GmbH	<input type="text"/>	set
WMOStationCode	0	<input type="text"/>	set
Comment		<input type="text"/>	set
Longitude	13524700	<input type="text"/>	set
Latitude	52430200	<input type="text"/>	set
Zenith	1500	<input type="text"/>	set
Azimuth	0	<input type="text"/>	set
Altitude	45	<input type="text"/>	set
UseAltitude	0	<input type="text"/>	set
LoggingTime	15	<input type="text"/>	set
Unit	0	<input type="text"/>	set
Layer	3	<input type="text"/>	set
TimeZoneOffsetHours	1	<input type="text"/>	set
BlowerMode	0	<input type="text"/>	set
RangeResolution	3	<input type="text"/>	set
RangeStart	15	<input type="text"/>	set
RangeEnd	15345	<input type="text"/>	set
RangeHrDim	32	<input type="text"/>	set
UAPD	0	<input type="text"/>	set
ApdControlMode	3	<input type="text"/>	set
TestMode	0	<input type="text"/>	set
LaserMode	1	<input type="text"/>	set
PeltierMode	1	<input type="text"/>	set
PowerSaveMode	0	<input type="text"/>	set
Standby	0	<input type="text"/>	set
BackscatterMax	40000000	<input type="text"/>	set

Fig. 17: Web interface, config system upper part in service mode: access on system configuration parts.
In superuser mode some parameters are not listed for security reasons.

Fig. 18 firmware updates can be uploaded in super user mode. New firmware files are packed as protected zip files. The packages can not be modified by the user. New firmware releases are still published at the Jenoptik sftp server. Until 2015 a new server from Lufft will publish new releases too. Before updating the firmware consult the readme files and Lufft engineers or advanced service users.

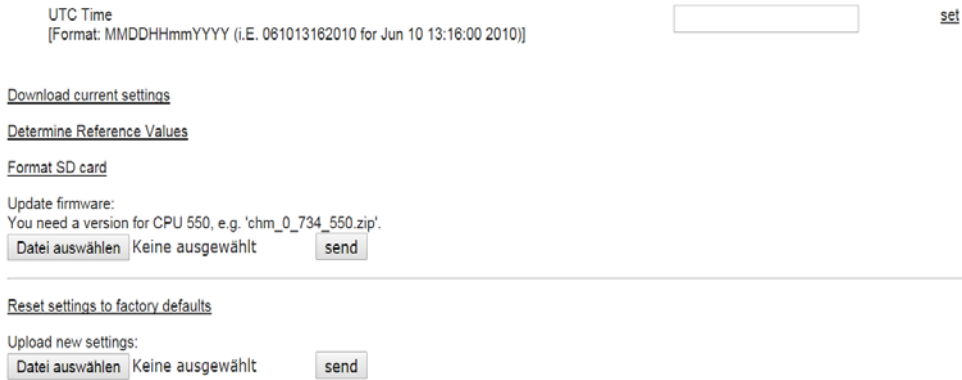

Fig. 18: Web interface, tab config system lower part in service mode: access on system configuration parts. In superuser mode some parameters are not listed for security reasons.

Parameter	current Value	new Value
RS485Number	16	<input type="text"/>
Baud	5	<input type="text"/>
BaudAfterError	5	<input type="text"/>
Transfermode	2	<input type="text"/>
TransfermodeAfterError	2	<input type="text"/>
IgnorChars	06	<input type="text"/>
NumberOfLayer	3	<input type="text"/>

Fig. 19: Web interface RS485 configuration panel (service mode): In superuser mode the upload option for a new telegram format is missing. Please ask us if you are planning to setup your own telegram file.

The upper section of process warning tab in figure 20 is mainly used by the Lufft service to identify firmware problems and special errors. The lower section shows information about the advanced file distribution (AFD) mode. If AFD mode is switched on the status of transferred files is shown. The properly setup or any mistakes have been done in the configuration with the AFD configuration file can be identified.

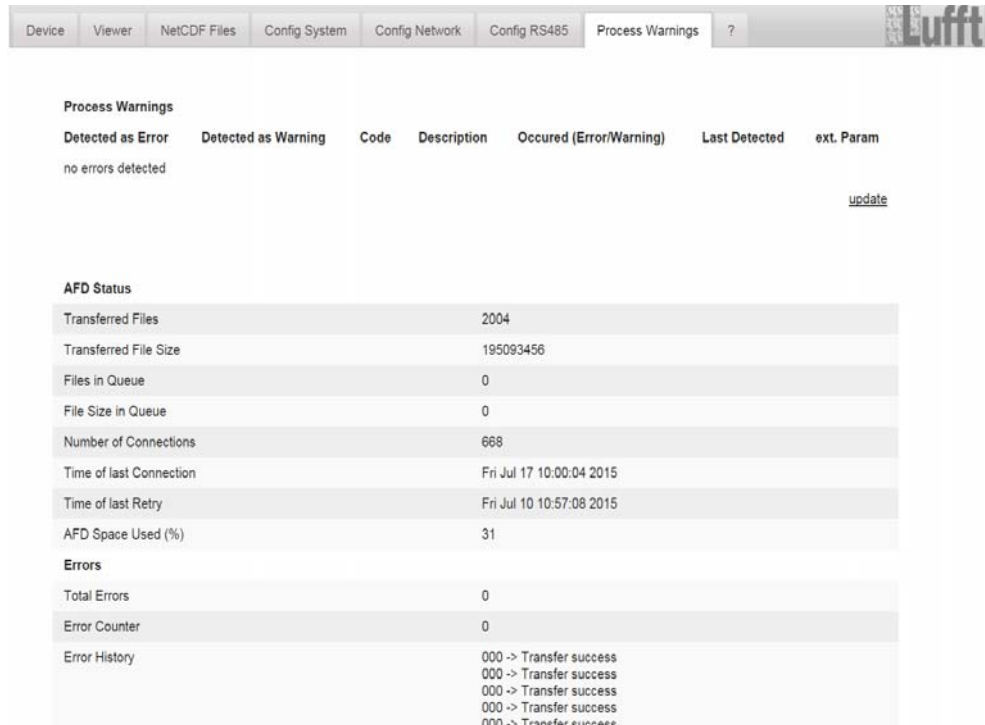

Fig. 20: Web interface: process warnings and error log, AFD status is only visible if AFD mode is on.

8.7.1 Time Server

A ntpd Linux job is implemented in the Linux system (Figure 15). In the configuration file ntpd.conf the time servers are listed. One time server is pre-configured: ptbtime1.ptb.de. If the system can detect a time server, it will be used immediately.



The user should avoid automatic time settings using the date-time command (RS485) and the ntpd process via Ethernet at the same time.

8.8 AFD Mode

The advanced file distribution system (AFD) is supported since firmware 0.52. It is used to send out measured data in NetCDF format to a ftp server automatically. AFD is using the Ethernet interface.

It can be enabled in the web-interface (figure 15) in superuser mode. A configuration file called "afdsettings" has to be downloaded, configured and uploaded to fit with the local requirement.

AFD is pre-configured to submit three 5 minute NetCDF files every 15 min. The NetCDF files can be merged again to 24 hour files by the user.

Below the configuration file "afdsettings.txt" is listed. The official file name is "dir_config". More information about the commands listed here can be found on the [DWD -AFD web-page](#). Hashes (#) are used to comment out commands.

Configuration file "afdsettings.txt"

[directory]

/tmp/afd/netcdf/afd-src

[dir options]

delete unknown files 0

delete queued files 6

[files]

*

[destination]

[recipient]

ftp://user:password@host_ip/path/%h/%tY/%tm

[options]

priority 9

create target dir

time */15 * * * *

lock DOT

exec -d bzip2 %s

age-limit 3600

The full format of the afdsettings file is important. If you download the example file from the ceilometer replace the settings carefully step by step. „#" is used to make a comment instead of an instruction.



Example for the file "afdsetting.txt"

Ftp server 192.168.1.51

Subdirectory form root on server: /home/chm_data

user name: afd

password: eXample

...

[recipient]

ftp://afd:eXample@192.168.1.51//home/chm_data/%h/%tY/%tm

[options]

priority 9

create target dir

time */15 * * * *

lock DOT

age-limit 3600

exec -d bzip2 %s

...

Every 15 minute bzip compressed files are transferred to a directory specified by subdirectory/hostname/year/month. Hostname "%h" is the instrument name like CHM060001, year "%tY" and month "%tm" are specified by the instrument time settings.

A double slash // after the IP address indicates that the path starts from root directory, a single slash / that it starts from the ftp home directory.

A ftp path in a windows directory may look like this:

ftp://afd:eXample@162.168.1.51/%h/%tY/%tm

The file will be stored in the home directory of the ftp server in the sub path /%h/%tY/%tm.

The command „time * * * * *” sends out the 5 min NetCDF file immediately when it is generated.

8.9 Telegram over Ethernet

The software implementation over the Ethernet interface provides also a method to receive data telegrams. The raw data telegram described in 8.3.5 can be polled.

On Windows operating systems the Nmap/ Ncat binaries can be downloaded and installed from the server <http://nmap.org/ncat/>, The web-page provides also various binaries and source codes for other operating systems.

After installation and setup the data telegram can be accessed by entering the polling command:

```
ncat <IP-address> <Port>
```

For example:

```
ncat 192.168.100.101 11000
```

or the old release from ncat:

```
netcat 192.168.100.101 11000
```

The port number is up to firmware release 0.726 8000, after that (December 2014) it has been changed to port number 11000.

The raw data telegram is still uuencoded like in the RS485 transfer mode and must be decoded before it can be read.

9 Data Evaluation/ Sky Condition Algorithm (SCA)

The ceilometer CHM 15k is a laser remote sensing instrument with a build in sky condition algorithm (SCA) generating cloud ceilings, cloud penetration depths/ thickness values. Moreover, the cloud cover (cloud amount in eights) for the total coverage in any altitude and for the base layer is determined and the vertical visibility is delivered. An aerosol layer algorithm based on wavelet algorithm detects almost two different aerosol layer heights. Haze and precipitation type output is encountered and transmitted within the sky condition index parameter.

This chapter does not contain the latest changes in the SCA algorithm. There will be an update of this chapter available. Please ask for a separate description, which is available upon request!



9.1 Laser remote sensing

One near infrared laser probes the sky vertically from ground to 15000 m. Targets like aerosol layers and clouds show up as echoes with certain backscatter intensity and signal extinction. Molecular absorption of as well as Rayleigh scattering by air molecules is negligible at a laser wavelength of 1064 nm. The distance from ground is calculated from the travelling time of the laser pulses.

9.2 Data preprocessing and averaging

Data pre-processing is a major task before the different steps in SCA algorithm starts. The major reason to do it is to harmonize / normalize the data sets between different CHM 15k systems to get similar results, e.g. for cloud base heights, even if the sensitivity between instruments varies.

In figure 21 two profiles of a reference unit and a test unit are illustrated after the normalization process.

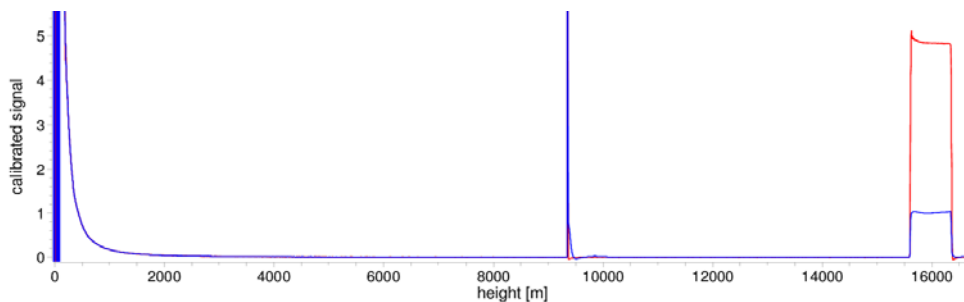

Fig. 21: Normalized signals $P(r)$ for reference unit (blue) and a test unit (red). A horizontal path is used with a hard target in 9.4 km distance for this method. At 16 km distance a test pulses are added to the signal.

The following formula is used to receive the normalized backscattered power:

$$P(r) = \frac{P_{raw} - b}{c_s \cdot O(r) \cdot p_{calc}}$$

with, P_{raw} as raw backscatter profile (photon counts), b . baseline, p_{calc} : average test pulse intensity, $O(r)$ overlap function, c_s : calibration constant and $P_C(r)$ is the normalized backscatter signal.

In another step, normalized data are calibrated to get attenuated backscatter values β_{raw} , which are stored in the NetCDF files. For cloud processing, and aerosol layer determination another pre-processing step will taken into account, which is shown in figure 22. It shows an example of the time average used to determine clouds in different altitudes from the range corrected backscatter signal. The values, where the time average starts to where it stops, here in the figure 3000m, 6000m) depends on the focus of usage of the ceilometer.

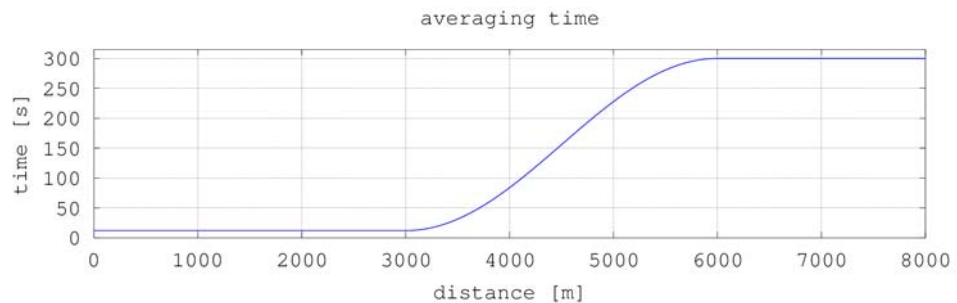

Fig. 22: Example for a time average used to calculate cloud bases in different altitudes.

9.3 Cloud ceilings/ cloud base heights

After successful pre-processing the averaged backscatter profile is used to identify cloud echoes, rain, fog, aerosol layers and discriminate these events from each other.

Figure 23 show a daily color coded intensity plot, where all layers with a significant backscatter value marked black.

The algorithm identifies rain and aerosol in these structures and calculates in a next step cloud bases and penetration depths.

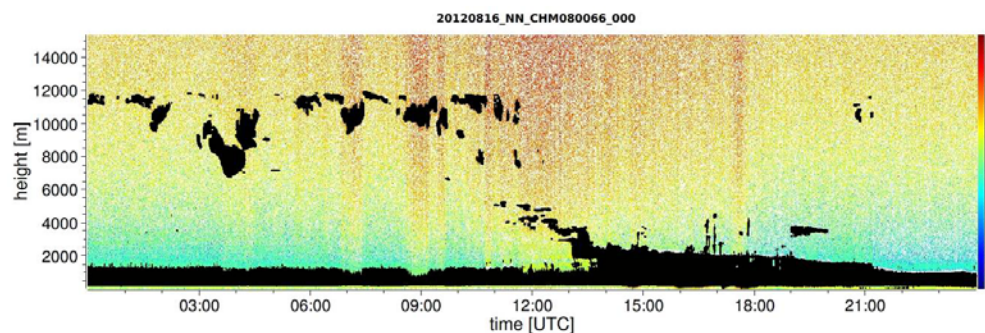

Fig. 23: Cloud detection algorithm.

9.4 Cloud Penetration Depth

A cloud penetration depth is established by identifying a cloud lower and upper level using the threshold level "ThAlphaStart(m-1E7)" (9.2). The subtraction of these values result in the cloud penetration depth. The "ThAlphaFactor(%)" is used to check the surrounding area of the calculated values. Both values combined deliver the standard deviation for the penetration depth of a cloud layer. Figure 24 show how the evaluation process for the cloud parameters are done.

9.5 Determination of Maximum Detection Range

The maximum detection range corresponds to the maximum distance at which significant signals can still be measured. It follows from averaged signal/noise ratios versus the distance range. At heights which are beyond the planetary boundary layer, significant signals are only generated by clouds. In presents of clouds the maximum detection range determined by means of the penetration depth of the highest detectable cloud layer.

9.6 Vertical optical range

The method for calculating VOR (vertical optical range) is described in the standard ISO 28902-1:2012. First an extinction profile α is calculated from the backscatter signal. The VOR is where the integral of extinctions equals 3.

$$\int_0^{VOR} \alpha(r) dr = 3$$

9.7 Precipitation and haze

Haze and precipitation types are detected by multiple scattering. Usually only single scattering is considered as a signal source. Strong atmospheric turbidity and high particle density respectively produce a stronger signal than usual close to the instrument. An integral over the signal in certain ranges is used to evaluate haze and precipitation.

9.8 Mixed layer height

Pollution from sources at ground level is spreading to a height depending on atmospheric conditions. The resulting aerosol layer are identified using a typical signature in the backscatter signal. The mixed layer height can be determined by finding the lowest aerosol layer height.

The quality of the identified aerosol layers are strongly dependend on local conditions and time. Table 16 shows an index describing the quality of the identified aerosol layers with respect to high accuracy and low uncertainty..

Q-Index	description
/ (telegram) -1 (NetCDF)	not enough raw data for calculation
- (telegram) -2 /NetCDF)	system hardware failure or system not ready
/ (telegram) -3 (NetCDF)	algorithm can't generate value
0	no layer detected, (index was not calculated in older firmware releases)
1	layer can be detected, but with a high uncertainty and low accuracy
9	layer can be detected with a high accuracy (less than 50 m)

Table 16: Quality Index description, of the aerosol layer height

9.9 Parameters for data evaluation

A set of parameters controls the data evaluation routine. The system dependent values are stored on the laser optical unit. They are listed within the table 3 and table 4.

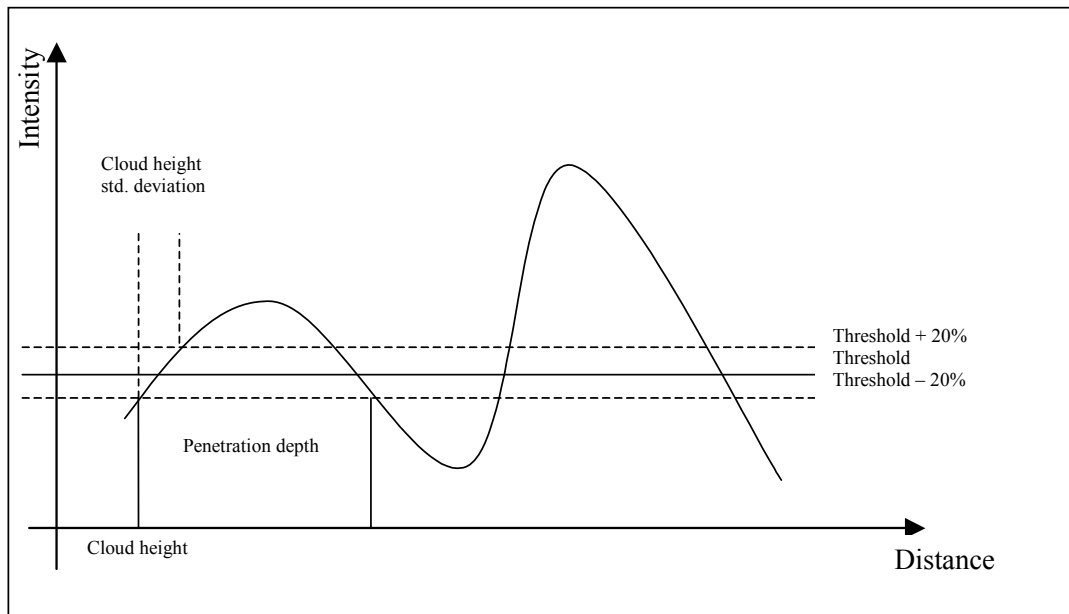

Fig. 24: Evaluation of cloud parameters, for the altitude of cloud bases and penetration depth the range vector will be corrected by the zenith angle

9.10 Cloud amount/ cloud cover (BCC / TCC)

The cloud amount value will be determined from calculated cloud bases, where their temporal history will be treated. The base cloud cover (BCC) from the lowest cloud base and the total cloud cover (TCC) are written in NetCDF files.

The considered time interval depends on the altitude, see Figure 25. For each altitude interval the frequency of cloud bases are calculated. This histogram will be smoothed using a height depending weight function. Within the smoothed frequency distribution, peaks will be separated. All cloud bases in the space of a peak will be clustered to one cloud layer.

The calculation of the total cloud cover value and the separated cloud layers are done within a rectangle depending on time and altitude. For this purpose the selected time interval (truncated cone) will be divided in a fixed number of small truncated cones. Parts containing cloud bases are counted against the total number of cone parts. The cloud cover values is expressed as a percentage value from these comparison. Finally the percentage value is expressed in oktas. Table 17 lists the WMO code for the cloud cover index. The please check the

firmware release if the code is fully supported.

oktas	description
- (telegram) -2 (NetCDF)	system hardware failure or system not ready
/ (telegram) -1 (NetCDF) -3 (NetCDF)	cloud is indiscernible for reasons other than fog or other meteorological phenomena, or observation is not made
0	clear sky
1	1 okta : 1/10 - 2/10
2	2 oktas : 2/10 - 3/10
3	3 oktas : 4/10
4	4 oktas : 5/10
5	5 oktas : 6/10
6	6 oktas : 7/10 - 8/10
7	7 oktas or more, but not 8 oktas : 9/10 or more, but not 10/10
8	8 oktas : 10/10
9	9 - sky obscured by fog or other meteorological phenomena

Table 17: Cloud amount / cloud cover values related to WMO code 2700.

9.11 Sky condition index (SCI)

The sky condition index is written in the extended data telegram and is a standard variable of the NetCDF file. It should allow the user to better interpret data, e.g. when clouds are not detected. In older CHM 15k system the variable was handled as precipitation index. It is used in the following way:

Value	Description
-- (telegram) -2 (NetCDF)	system hardware failure or system not ready
00	no fog nor precipitation detected
01	rain
02	fog, no clouds detectable
03	snow or freezing rain
04	window transmission reduced, droplets on the window
// (telegram) -1 (NetCDF) -3 (NetCDF)	observation is not made, in NetCDF, the numerical values -1, -3 are used instead of // in the telegram

Table 18: Sky condition index (SCI)

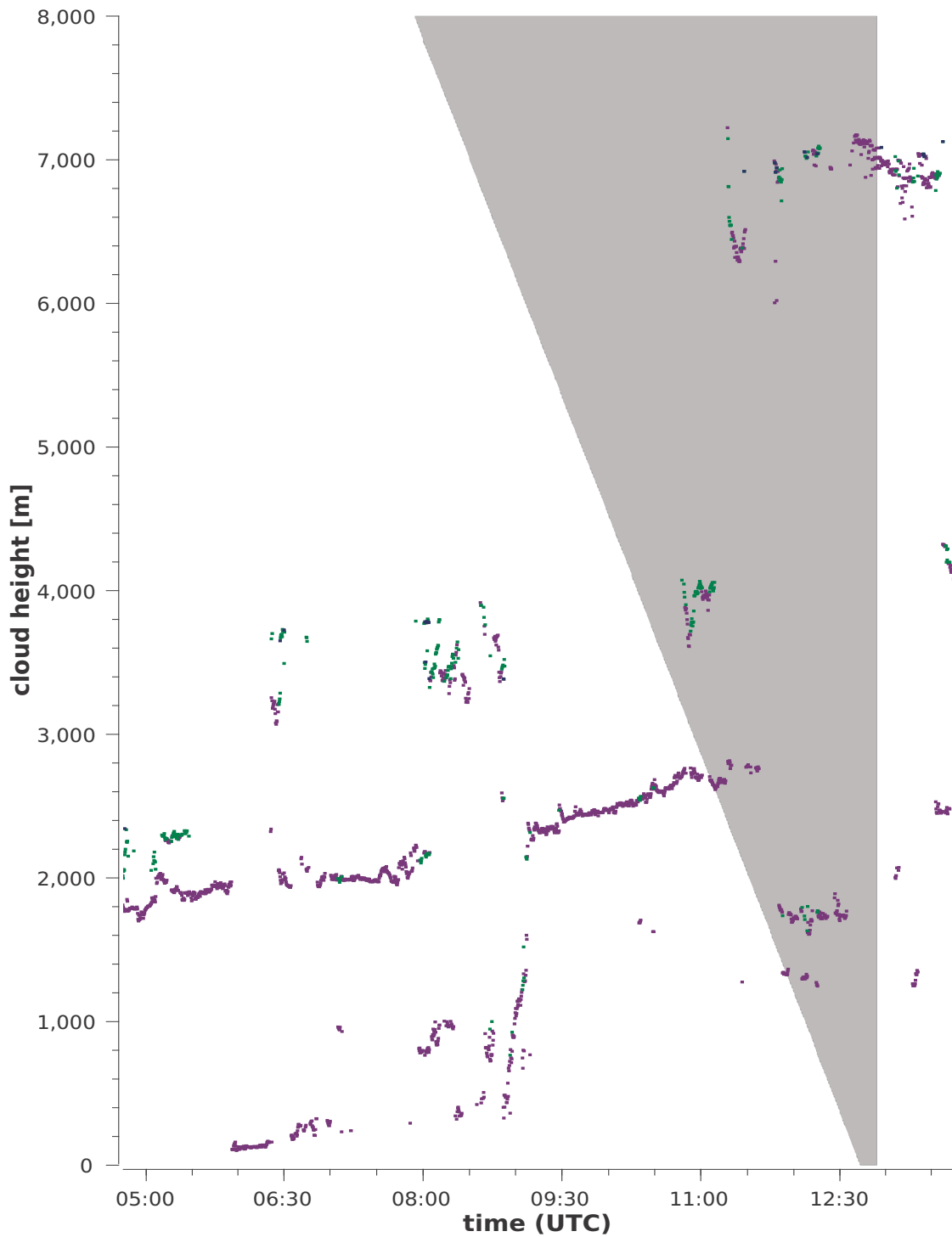

Fig. 25: Cloud amount algorithm: The selected time interval used for the cloud cover calculation depends on the range, a truncated cone function is used for the calculation.

10 Cleaning, Maintenance & Service Instructions

DANGER

Laser radiation! There is danger of eye injury!

Class 1M laser radiation, if viewed over an extended period of time, may cause damage to the eyes such as glare or irritation or even full loss of eyesight. Do not directly look into the laser beam. Under no circumstances should the laser beam be directly inspected with the help of optical instruments (e.g. field glasses). Make also sure that no items with a reflecting surface (e.g. watches) are placed in the beam path.



10.1 Cleaning

Interval	Cleaning	Comment/Aids
Quarterly ¹	Clean glass panels (Fig. 26) mainly with a lot water and some mild soap. Use your hands to dispense some soap at the windows, clean again with water, use distilled water for the finish.	Dishwashing liquid, water, hands,
As required	Remove sedimentation from space below casing top	Neutral cleaning agents, micro-fibre wipes
As required	Remove potential plant pockets in front of fan inlet grids (rear side)	Keep fan intake area unobstructed, see Fig. 27
As required	Remove snow ²	Keep fan intake area unobstructed, see Fig. 27

Table 19: Cleaning schedule and cleaning action

1 for average dust load level of 25 -35 µg/m³ in the air

2 as soon as snow reaches the air inlet plane of the fans

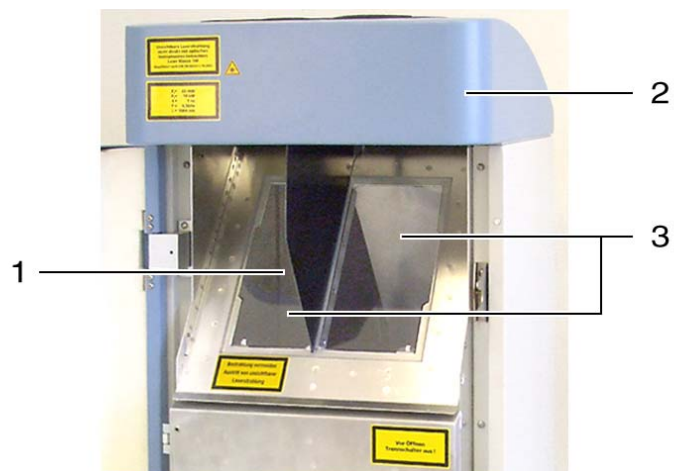

Fig. 26: Glass panels have to be cleaned

- 1 Laser outlet on left side
- 2 Casing top
- 3 Glass panels; windows shall be cleaned without micro-fibre wipes



Fig. 27: Fans inlet. Remove snow, sedimentation,...



NOTE

The CHM 15k Cloud Height Meter requires regular maintenance. Maintenance work may not be performed by anyone other than service personnel of G. Lufft GmbH or specially trained customer technicians. For detailed instructions on maintenance, you should consult the Service Manual.

10.2 Maintenance Intervals & Action

CAUTION

Danger of physical injury by electric current!
Use miniature circuit breaker to cut power supply before any kind of maintenance or repair work at the Cloud Height Meter.



Interval	Preventive maintenance action	Comment
regular checks	check of intactness of air dehumidifier bag CONTAINER DRI II"	
at least once a year	Replace air dehumidifier bag CONTAINER DRI II"	
Three- to four-yearly	Replace laser optic module if signs of laser wear - falling repetition rate; replace SD-card	only service personal
Five-yearly	Replace inner door rubber seal (material fatigue)	only service personal
Five-yearly	Replace lightning ductor following lightning strike	only service personal
Eight-yearly	Replace electronic mainboard	only service personal

Table 20: Preventive maintenance intervals and action

10.2.1 Replacement of Air Dehumidifier Bag [67]

- Open outer and inner door
- Remove air dehumidifier bag (item 2 of Fig. 18)
- Glue new air dehumidifier bag to inner door
- Close inner and outer door

10.2.2 Replacement of Rubber Seal [34] at Inner Door

- Open outer and inner door
- Detach cable [69] of thermostat at clip terminal XK013
- Remove rubber seal from inner door (item 1 of Fig. 18)
- Mount new rubber seal to inner door (using suspension points)
- Close inner and outer door



Fig. 28: Air dehumidifier bag (2) and rubber seal (1).

If you have questions or if a procedure mentioned in the User Manual fails to fix a particular problem, you are advised to contact your on-site service technician or G. Lufft GmbH.



NOTE

For other detailed information, which is in excess of this User Manual (maintenance, replacement and system assembly particulars), you should refer to the Service Manual. The Service Manual is only available to Lufft personnel or specially trained technicians who have a documented proof of qualification (valid certificate) to handle respective maintenance and service work responsibilities.

11 DataClient - Terminal software for CHM 15k

The main purpose of the Terminal program DataClient is receiving data telegrams from CHM 15k instruments and storing these data on local disks. Moreover, it can also be used for remote maintenance and diagnosis of connected CHM 15k instruments. Basic commands are included for reading CHM 15k parameters, and with some restrictions also writing these parameters. Commands are described in chapter 8 of this manual.

11.1 Software Installation

DataClient requires a Windows 7, Vista, XP or (2000) operating system to install the software and its runtime engine. Precondition is that instrument communication could be established via the RS485 connection line to the CHM 15k, which is typically done by a RS232-RS485 or USB-RS485 interface adapter.

The DataClient software is included in each CHM system delivered from Lufft. The standard CD includes:

- full installation: setup file for the program and the runtime engine
- single program files, which can be used for updates if the runtime was already installed.
- manual of the CHM 15k instrument
- additional information/ tools

In addition, another product CD exists, which includes a visualization program of raw data.

While the standard installation process is running, the installation directory can be changed from its default values.

Default: c:\Lufft\Programs

Additional directories used by the program are:

- c:\Lufft\Measure (data base path)
- c:\Lufft\Image (used by the old software JO-Visual only to save images)
- local temporary file path to save raw data.

The user needs read and write access to the Lufft program and data folder and the "temp" folder. Because the measure and image paths are not fixed, be sure that the configuration file JO-Visual.ini for the old visualisation program and the path variables for the DataClient program have been changed in the same way. Starting from August 2014 the new visualization program CHMViewer has replaced the JO-Visual software.



11.2 Convention for the file names

DataClient generates ASCII files with a file name and path convention depending on the telegram (see chapter 8.3.3, 8.3.4, 8.3.4) and the "filestructure" start parameter.

Please notice that the standard telegram does not contain the information of the instrument name of the instrument. Without additional queries the name is set to "CHMstndrd". The instrument name can be set by querying for the device-name (old fabname) or for all parameter in the start sequence form field or within the autostart process.

generated path	\DEVICE\YYYY\mm\...
Daily ASCII telegram files (filestructure =0)	DEVICE_YYYY-MM-DD.dat
Hourly ASCII telegram files (filestructure =1)	dd\DEVICE_YYYY-MM-DD_hh.dat
15 min ASCII telegram files (filestructure =2)	dd\DEVICE_YYYY-MM-DD_hhmm.dat
Raw data file (filestructure=0)	YYYYMMDD_[location]_DEVICE.nc
Raw data file (filestructure=1)	dd\YYYYMMDD_hh_[location]_DEVICE.nc
Raw data file (filestructure=2)	dd\YYYYMMDD_hhmm_[location]_DEVICE.nc

Table 21: Convention of DataClient file names

11.3 Start dialog

For the DataClient a start dialogue exists to configure the instrument (section 11.3). Furthermore an autostart mode exists to avoid the pop up of the start dialogue. The command line parameters and the pre-installed autostart.cmd example file are explained in section 11.10.

Immediately after start the following dialog window appears.

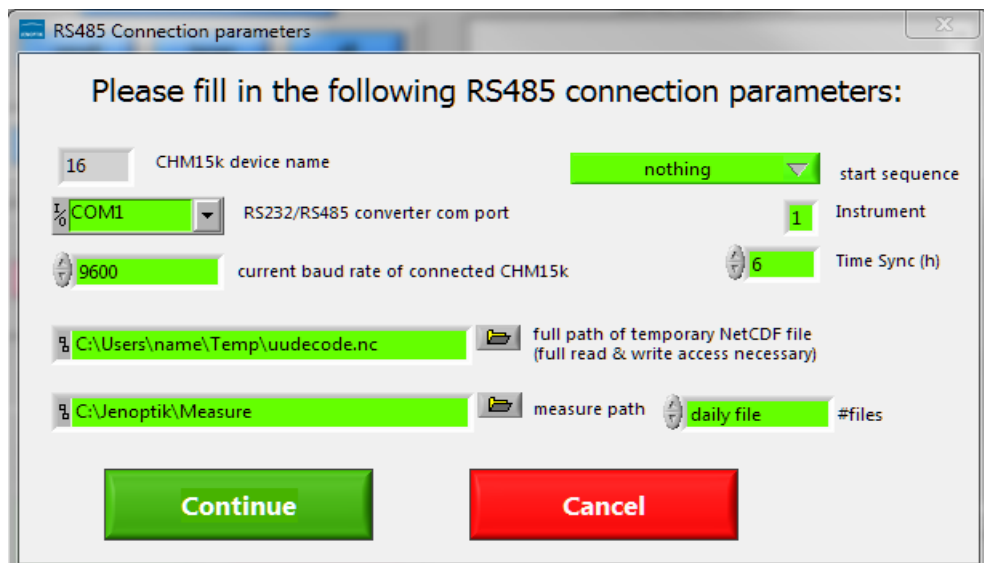

Fig. 29: Start dialog window DataClient

The four input fields on the left side should be filled with appropriate values. If the current baud rate of the connected CHM 15k is unknown, then use the value "9600, which is the default baud rate. A higher baud rate, eg. 38400, is recommended for raw data transfer and could be changed later on, see top figure 30.

If you poll the CHM 15k many times with an incorrect baud rate the CHM 15k will automatically set its baud rate to the "BaudrateAfterError" value, which is also predefined to 9600 Baud, after one logging interval.

To go on:

- With "Cancel" the program terminates.
- With "Continue" the program will enter normal operation mode with five pages, which are explained in the following sections.

11.4 Communication tab

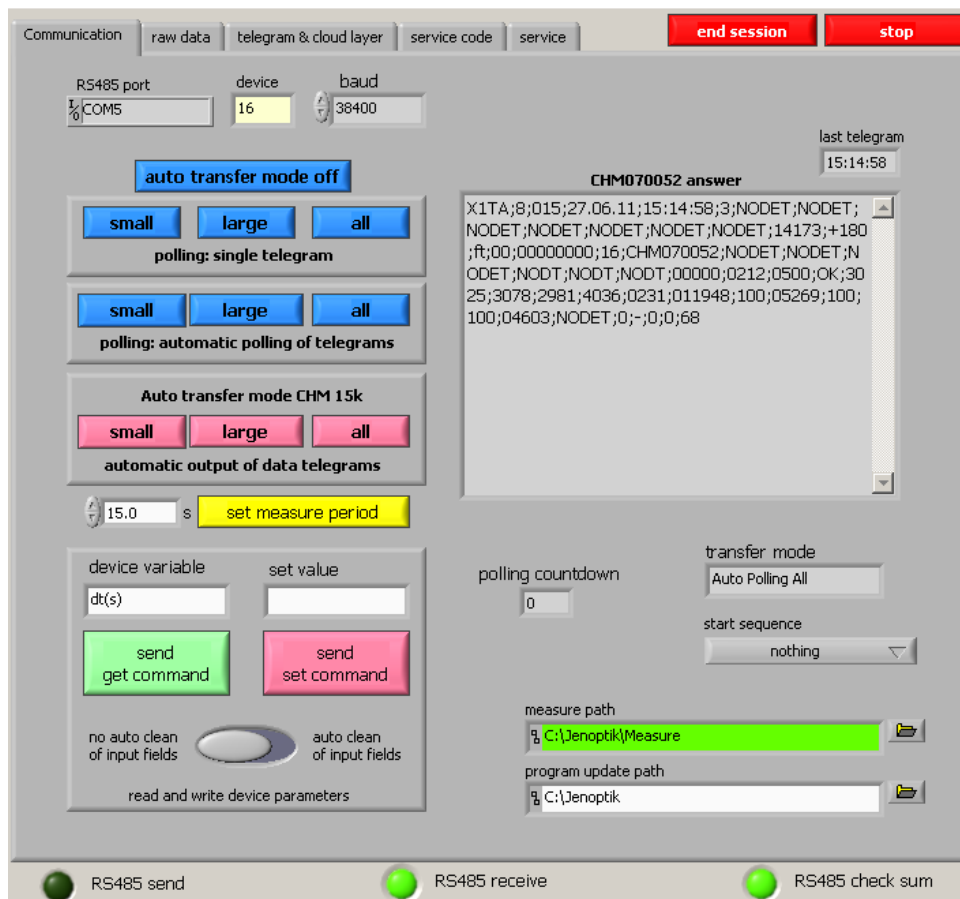

Fig. 30: Main page "Communication", where all actions are carried out. The remaining four pages serve the monitoring of the measuring data as well as service information.

All control elements are placed on the left side of the page. Responses of the

CHM 15k can be read unfiltered in the display box „CHM 15k answer“. The raw data part of raw data telegrams is not displayed here. In addition, they are shown in the service tab field.

Details of control elements. The top row encloses the interface parameters:

- RS485 port: Here the RS232 port which is connected to the RS232-485 adaptor is displayed. It can only be changed by the initial dialogue (see above).
- RS485 number: The RS485 ID-number of the connected CHM 15k device. The value “16” should only be exchanged if necessary.
- baud: With this electoral switch the baud rates 1200, 2400, 4800, 9600, 19600 or 38400 bauds can be selected. Note, that the factory default value is 9600 baud.

Below there is a button named “auto transfer off”. Pressing this button means, that all previous automatic transfer modes will be cancelled.

The next block contains three buttons for single telegram acquisitions:

- small: The standard data telegram is requested, see user guide, chapter 8.3.3
- large: The advanced data telegram is requested, see user guide, chapter 8.3.4
- all: The raw data telegram is requested, see user guide, chapter 8.3.5

The next block contains three buttons for automatic polling of data telegrams.

Below there is an input field for the internal measure period (in seconds) of the CHM 15k. The associated button must be pressed, if this value should go into effect for the CHM 15k device. Nevertheless, this value is also used as the time between automatic polling mode acquisitions described in the previous paragraph, and changes of the value in this sense are applied **without** pressing the button “set measure period”!

The next block contains three buttons for automatic telegram output, initiated by the CHM 15k itself, i.e., not by polling.

Remark: All six automatic telegram modes will be cancelled by pressing the button “auto transfer off”, or also by acquisition of one of the three single telegrams.

Now a block follows for reading and writing internal CHM 15k parameters:

- device variable: Here the name of the concerning CHM 15 parameter has to be specified. A summary of these parameters can be find in the user guide, tables 4 and 16.
- set value: Value for the “send set command”.
- send get command: The current value of the parameter is displayed in the box “CHM 15k answer” on the right side.
- send set command: Value "set value" is transmitted to the CHM 15k. Provided that the suitable parameter is really alterable and is in the permissi-

ble range, the successful parameter update will be acknowledged in the box "CHM 15k answer". If one of these restrictions is violated, there is no acknowledgement and the parameter is not changed. For safety reasons some of the parameters are alterable only in the service mode, see user guide, section 8.6.

- switch "auto clean of input fields": If activated, the two input fields "device variable" and "set value" will be erased after each set or get command

Finally another two paths are adjustable which concern local paths of the computer, where the DataClient runs:

- measure path: In this directory the telegram messages of CHM 15k will be saved in subdirectory structure, which depends on device name and date, for later evaluations.
- program update path: If a software update has to be carried out (see last page) this path must contain the new program files to be transmitted. This path is to be set here only in the case, if during a running update process DataClient is terminated and is newly started later again. In the latter case the update directory has to be customized immediately after the restart.

11.5 Raw Data

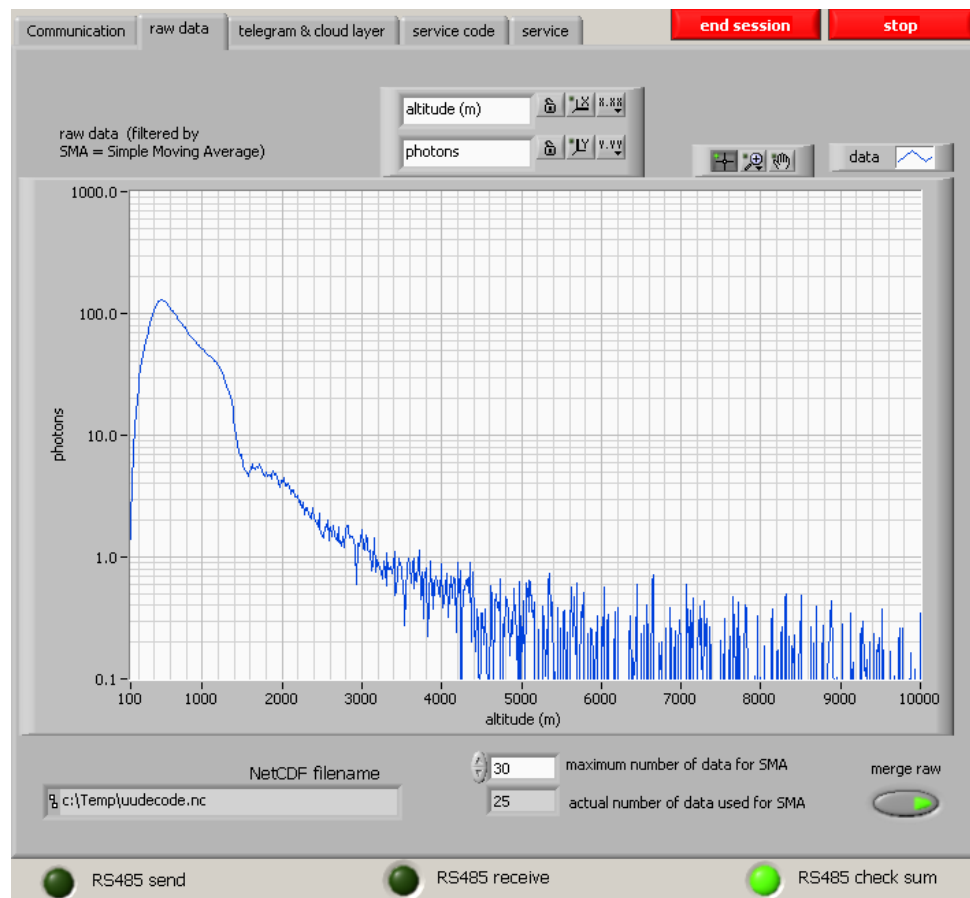

Fig. 31: Raw data tab. In the graph shown here the data of the last transmitted raw data telegrams are captured.

In fact, a simple moving average (SMA) filter is applied on the last 10 raw data telegrams, this number 10 is changeable in the input field "maximum number of data for SMA". If the value 1 is set in this field, the raw data of the last received raw data telegram are displayed in the graph. The field "actual number of data used for SMA" contains the number of raw data records used for SMA calculation - without change of parameter "maximum number of data for SMA" this value should grow with succeeding telegrams up to 10.

"NetCDF filename" specifies the entire local path of the last transmitted raw data telegram, this file is overwritten every time a raw data telegram is received.

11.6 Telegram & Cloud Layer

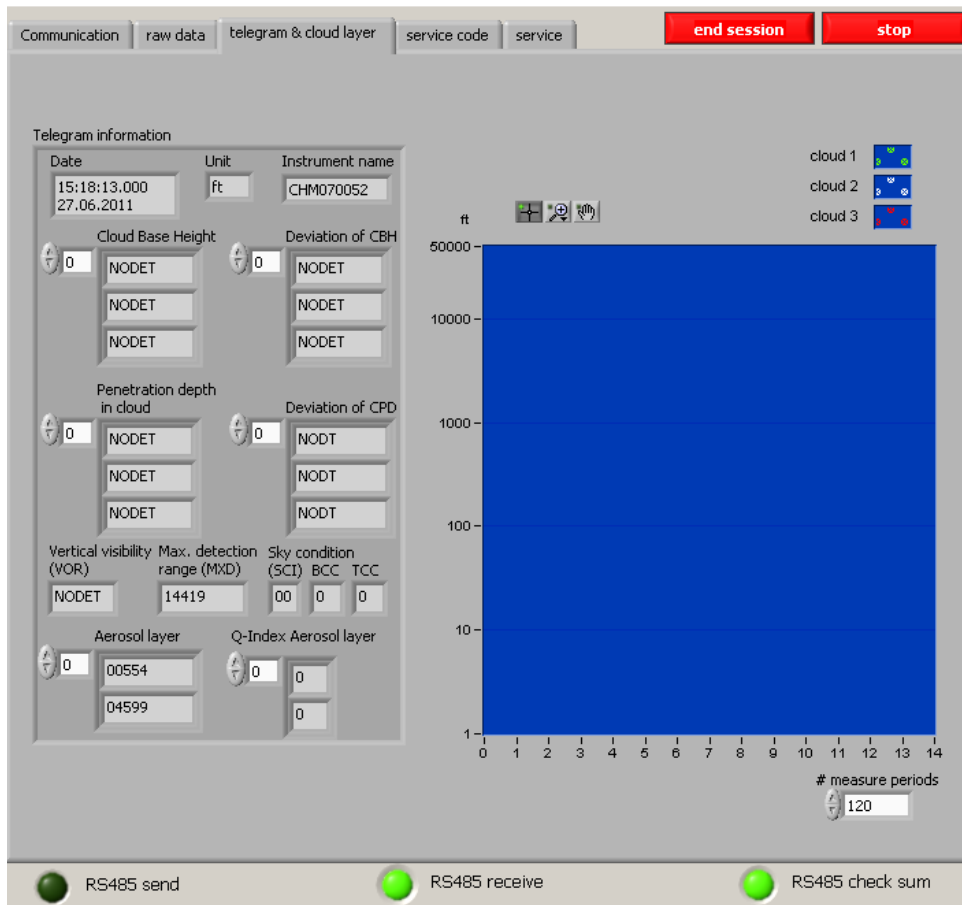

Fig. 32: All types of telegrams contain cloud layer and associated penetration depths; in the advanced and raw data telegrams also the standard deviations of these values and aerosol layers are transmitted. These values are displayed on the left side. The right side shows the course of cloud heights over the last 120 (tbd) telegrams.

In the above example we don't see recognized cloud layer, hence the field for cloud layer is marked with NODET or NODT, short form for "not detected". The vertical visibility is also not detectable and the detection range is very high. Two aerosol layers are identified. In sum we can assume clear sky condition.

11.7 Service Code

Each telegram message contains a service code field of 32 bit. The service code tab lists clearly the Bits by their meaning, see also chapter 8.5 for service code details. A signal light indicates an alert of the suitable function.

During the start phase of CHM 15k some of these signals may light up. However, after some minutes the CHM 15k should enter normal operation mode with all lights switched off. Lights are hints for trouble-shooting.

Every received message from CHM 15k (telegrams & set/get command answers) contains a checksum in terms of two's complement. Transmission is checked by this gibberish total, proper transmission is indicated by value zero in the field

"check sum RS485". Non-zero values indicates transmission problems, cables and transformers must be checked carefully (proper grounding, termination and pull up/pull down resistors etc.) and/or the transmission speed should be lowered.

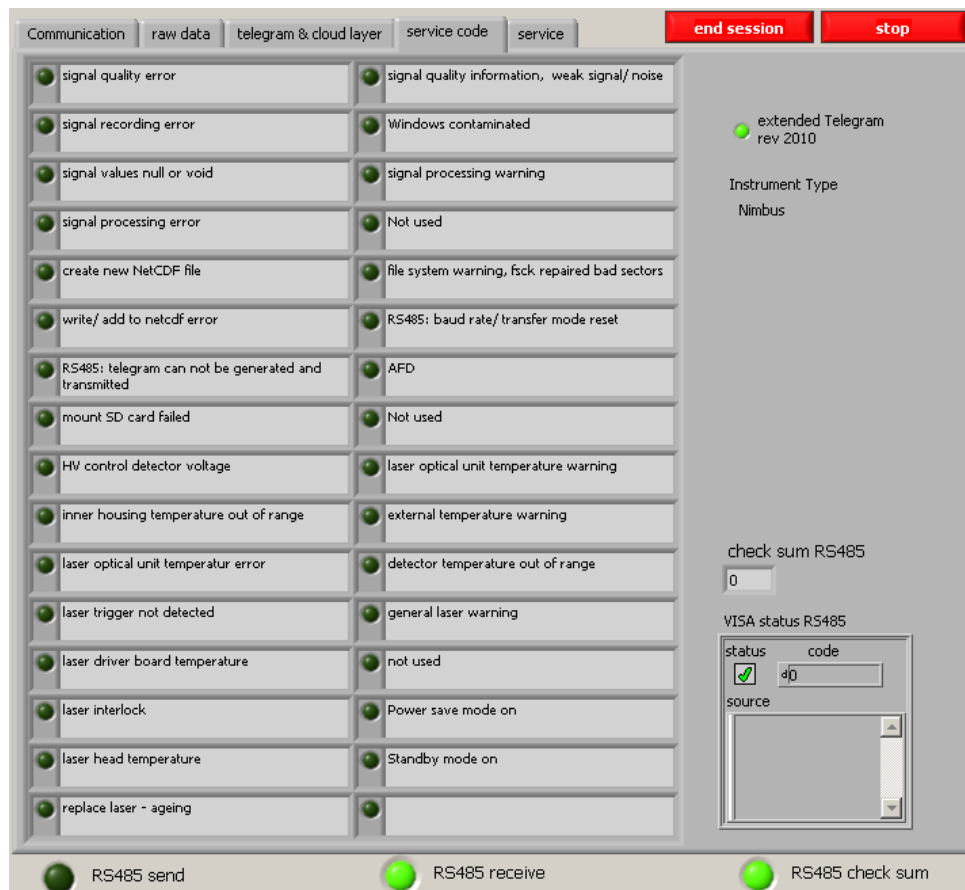

Fig. 33: Service Codes in DataClient

11.8 Service & Software Update

The DataClient contains no longer a firmware update feature. Please use the web-interface of the WAN/ LAN or DSL interface for firmware updates.

There is an additional button "get all parameters" on this page. All parameters of the CHM 15k will be saved into the local text file. Its name is displayed automatically after you pressed the "get all parameters button.

"Merge Raw" writes the sequential acquisition of the NetCDF raw data files to disk. It is possible to switch off this function.

11.9 General available controls or indicators

At the bottom line of the window there are three light indicators:

- RS485 send: Normally this light should only blink for a short moment, while sending commands. An exception is a running software update, where large blocks of data will be sent to the CHM 15k, in this case this light shines for some seconds.
- RS485 receive: This light shines while receiving data from CHM 15k. During this period send actions (like set/get variables) must not be done because there is only a half-duplex RS485 connection to the CHM 15k, so simultaneous sending and receiving is not possible.
- RS485 check sum: Each answer of CHM 15k (telegram or set/get command confirmation) is closed by two checksum bytes (complement of two). The result of check is indicated by this light: green - ok / red - failure.

There are two buttons in the upper right corner of the program window:

“end session”: The current session is finished, and the very first start dialog (with RS 485 connection parameters) appears again. Now possibly changed connection values should be filled in and another session can start.

“stop”: The program terminates.

11.10 Autostart and command line parameters

The file “Autostart_DataClient.cmd” allows an automatic startup procedure of the DataClient software. The default path variables listed below are used to have a separate path for the measuring software, the data and configuration files, which is not restricted by the Windows operating system. The standard file includes all command line options, which can be changed due to user requirements:

```
set CHMDIR=%systemdrive%\Lufft\Programs
set MPATH=%systemdrive%\Lufft\Measure
start /B %CHMDIR%\DataClient.exe -device 16 -com COM1 -baud 3 -ncpath
%TEMP%\uudecode.nc -measurepath %MPATH% -startseq 7 -utcupdate 6 -
instrument 1 -filestructure 0 -nostartdialog 1
```

Remark: start... command without linebreaks!

It is important that the current internal baud rate of the CHM 15k (set in previous sessions) must coincide with the baud rate in this command line, in this example value 3 means 9600 baud. Otherwise connection failures will occur, see chapter 11.3 (start dialog). In this example the CHM PC clock is synchronized every 6 hours.

DataClient can be invoked with one or more of the following command line parameters:

- `-baud <index>`:

Possible values of <index> can be 0 (1200 baud), 1 (2400 baud), 2 (4800 baud), 3 (9600 baud, default), 4 (19200 baud), 5 (38400 baud), 6 (57600 baud) or 7 (115200 baud).

- **-com <port>:**
Usually <port> is one of the serial ports ASRL1::INSTR (default), ASRL2::INSTR, and so on. Depending on the Labview environment on the host PC, the alternative names COM1, COM2 may be available too.
- **-device <number>:**
The default value is 16, suitable for the factory default RS485 number of a CHM15k.
- **-measurepath <path>:**
<path> specifies the main directory of locally saved raw data telegrams (NetCDF). Default <path> is D:\Measure
- **-ncpath <filename>:**
<filename> specifies the full qualified filename (i.e. including path) of a required temporary NetCDF file for the decoding of raw data telegrams. Therefore the user must have read and write access to this path. Default <filename> is C:\WHM\uudecode.nc
- **-utcupdate rate <hours>:**
Any positive value means that the internal CHM PC clock is synchronized with the client PC clock (converted to UTC) every <hour> hours. Default value for <hour> is 0, i.e., no synchronization is done.
- **-startseq <number>**
Defines a list of parameter queries in the start up process of the software. "7" queries all parameter values (transfermode, logging time and filename).
- **-instrument <number>**
Parameter changes the type of the instrument, e.g. changes the service text of status codes. The default number for Nimbus systems is "1" and for old CHM 15k systems "0".
- **-filestructure <number>**
Telegram files and NetCDF files are saved with a specific file structure and number of files in the predefined directory: "0" means a daily files is generated, "1" hourly files and "2" 15 minute files are generated.
- **-nostartdialog <number>**
The value „1" skips completely the start dialogue, "0" just affects the input fields of the start dialog (Fig. 29).

11.11 DataClient Software Versions

Software #	Description	Published
2.35	Latest 2.x release of DataClient based on Labview 7, which was limited to Windows 2000, XP	Dec, 2010
3.36	First issue base on Labview 10, tested for Windows 7& XP	March, 2011
3.44	NetCDf parameter added: nn1-nn3, temp_lom, default path name changed, instrument variable added, Nimbus service codes added, RS 485 timing optimised	June, 2011
3.50	15 min & 1 h telegram and NetCDF file storage integrated Parameter "-filestructure" added in command line for autostartup procedure (0: 24 h, 1: 1 h , 2: 15 min)	September, 2011
3.51	small bug fixes in written daily NetCDf files	February, 2011
3.70	compatibility with new firmware 0.7x and new NetCDF format from Nimbus instruments	February, 2013

Table 22: Software releases DataClient

Annex

A Annex - Service Manual Contents

1. Basic Information
2. Safety
3. Technical Data
4. Functional Description & Setup
5. Malfunction & Trouble Shooting
6. Maintenance
7. Replacement & Wear/Tear Parts

B Annex - Example for querying a complete parameter list

A list of available RS485 parameters can be queried using RS485 interface

The following RS485 command queries for a parameter set:

get <RS485No>:Parameters<CR><LF>

The format structure is as following:

<STX><get <RS485No>:Parameters=<ParameterName1>:<TABS><ParameterValue1>

<ParameterName2>:<TABS><ParameterValue2> ...

<ParameterNameN>:<TABS><ParameterValueN><CR><LF><EOT>

<RS> is the ASCII character "Record Separator" (HEX 1E), and <TABS> stands for one or more tab characters (HEX 09). Changing the characters after receiving <LF> or <CR><LF> a clearly arranged list of all system parameters are generated. The number of tabs are chosen in a way that with a standard tabulator grid of 8 characters the names of variables and its values are well aligned in two columns. The JO-DataClient software has a special download option for the parameter file.

Parameter	Value
AfdMode:	1
Altitude(m):	36
ApdBkBreakDown:	368
ApdControlMode:	3
Azimuth:	0.000000
Baud:	5
BaudAfterError:	5
BlowerMode:	0
CHMTest:	0
DateTime:	"10.04.2012 13:55:25"
DeviceName:	16
DeviceType:	CHM15k
dt(s):	15
FabName:	CHM090104
Gateway:	10.64.102.1
IgnoreChars:	06
Institution:	Lufft
IPdhcp:	10.64.102.36
IPAddress:	10.64.102.136

Table 23: Example of the parameter list received over RS485 interface using the command "get 16:parameter".

Annex - Example for querying a complete parameter list

Parameter	Value
LaserPower:	50
Latitude:	52.000000
Layer:	3
Lifetime(h):	16355
Location:	Teltow
Longitude:	13.238620
MaxCrossTalkChars:	5
Netmask:	255.255.255.0
NtpMode:	1
NtpServer:	10.250.1.1
PowerSaveMode:	0
ServiceMode:	0
SerLom:	TUB080022
SetPeltier:	1
Standby:	0
SystemLifetime(h):	4763
TBCalibration:	0.206800
TimeOutRS485(s):	30
TimeZoneOffsetHours:	1
TransferMode:	3
TransferModeAfterError:	1
UApd:	1
Unit(m/ft):	m
UseAltitude:	0
Zenith:	0.000000
VersionLinux:	121201
VersionFPGA:	213
VersionFirmware:	704

Table 23: Example of the parameter list received over RS485 interface using the command “get 16:parameter”.

Annex - Example for querying a complete parameter list

Using the web- Interface the query command “download current settings” will download the complete set of parameters.

Example:

Parameter	Value	Description
** Standard User Configuration Parameters **		
DeviceName	CHM090104	CHMyyxxxx
dt(s)	15	2 - 3600 s, logging and reporting intervall
MeasureInterval	1000	200-265000 ms, measurement time
Unit(m/ft)	1	0; 1
Location	Teltow	default NN
Institution	ESW2	default NN
Comment		comment for NetCDF file header
Altitude(m)	0	0-99999
UseAltitude	0	
Longitude	12000000	
Latitude	51000000	
Azimuth	0	0-360 degree (x100)
Zenith	0	0-90 degree, default 0 vertical (x100)
TimeZoneOffsetHours	1	-12-+12, Offset from UTC in hours (CET=1, CST=-6)
BlowerMode	0	mode for blower control (0 = always enabled, 1 = off from 20 to 4, ...)
NtpMode	1	Mode for NTP (0 = off, 1 = on)
NtpServer	10.250.1.1	NTP Server
IPAddress	10.64.102.131	IP address
Netmask	255.255.255.0	Netmask
Gateway	10.64.102.1	Gateway
** Log **		
AfdMode	1	0; 1 AFD - logging on/ off
BackscatterMax	40000000	max value for colour scale backscatter plot in viewer
** Device **		
RS485Numbe	16	RS485 device name
StandBy	0	special mode
CHMTest	0	0; 1
DeviceType	CHM15k	instrument type: "CHM15k", "PLC", ...
AcqPrefetch	0	old data pre-loaded for processing

Table 24: CHM settings downloaded from web-interface

Annex - Example for querying a complete parameter list

PeltierMode	1	1= on (default), 0 = off
WindowReference	3600	Optical state * 1000
ApdCurrentReference	1995	
** ALG **		
NumberOfLayers	3	1-5, number of cloud layers in Netcdf und telegram
AlhAverageTimw	300	15-1800 (s), time average for ALH calculation
AlhAverageHeight	135	15-1000 (m), distance average used for ALH calc
AlhMinHeight	181	1-15000 (m), distance of min ALH height, detectable by CHM
** Control **		
ApdControlMode	3	APD control mode
ApdTemp	25000	detector temperatur target value m°C
UApd	0	1-500000 in mV
ApdBreakGap	2000	APD-Gap 1-100000 in mV
TubusTemp	35000	LOM temperature tarbet value in m°C
LaserMode	1	1= on (default), 0 = off, switch off can be used for test bench in service mode
WaveLength(nm)	1064	nm
RangeDim	1024	1-4096, size of range vector
Range2Dim	32	1-4096, size of high-resolution range vector
** RS485**		
MaxCrosstalkChars	5	0 -1024
TimeOutRS485	30	5 - 3600 s
IgnoreChars	6	list of special characters ignored by instrument: <ack>
** Ports **		
Baud	5	0=1200, 1=2400, 2=4800, 3=9600, 4= 19200, 5= 38400, 6=57600, 7=115200
BaudAfterError	5	
TransferMode	3	0 = polling, 1 = auto standard, 2 = auto extended, 3 = auto ex
TransferModeAfterError	3	
ServicePort	/dev/ttyO1	
UseRs232	0	Switch between RS485 (0) and RS232 (1)

Table 24: CHM settings downloaded from web-interface

Annex - Example for querying a complete parameter list

ModemMode	0	1 switch V24 modem on, if available instead of RS232
ModemPhoneNumber	11	phone number modem has to dial
** Settings from EEPROM in the optical unit **		
SerialOpticalUnit	TUB080022	TUByyxxx
LaserPower	50	0-100 in mW
TbCalibration	206800	0-1e+7, scaling * 1e+6
ApdBkBreakDown	368	0-500
LaserRate	6956	0-30000
TpRatio	53	not set in default config
TpRatioSnr	58	not set in default config
ApdTmGradient	2400	temperature gradient in mV/K
** Settings not in default Config **		
SlaveIP	0.0.0.0	not used for CHM 15k Nimbus
** Information to current versions and life times **		
Firmware	0.723	data processing version
FPGA	02.13	FPGA version
OS	13.12.1	operating system version
LaserLifeTime	24147	in hours
SystemLifeTime	43725	in hours

Table 24: CHM settings downloaded from web-interface

C Annex - CHM 15k Firmware Version

This manual corresponds to the firmware version 0.730 for the CHM 15k Nimbus.
Future changes will be notified here.

Linux Kernel software version: 12.12.1, FPGA software version: 2.13

Firmware published releases	Description	Published
0.1	first release	11/ 2010
0.3	div bugs solved, extended web interface, new commands for blower-mode	03/2011
0.450	bugs in cloud amount algorithm solved	05/2011
0.501	bugs in cloud amount algorithm solved, restart/ shutdown process corrected, corrupt NetCDF files solved. ntpd implemented	06/2011
0.535	AFD (ftp functionality) implemented, HV control modified, bug fixes	09/2011
0.550	Web-Interface redesigned; processing issues corrected; manual version I0; bug fixes	12/2011
0.556	large update including FPGA + linux Kernel; AFD options added; AFD layout changed to avoid memory errors, Warnings/ Error/ Status code: Detector signal control added; memory warning added to status code bit 22, temperature measuring issues fixed Acquisition changes: compatibility with polarization lidar, fancontrol modified	04/2012
0.590	range vector corrected for speed of light in air, cloud preview removed from web-interface, small bug fixes (fan control, temperature control) AFD config improved, manual J0	05/ 2012
0.704	large update new improved SCA based on new calibration method for Nimbus instruments, NetCDF format changed, e.g. new parameter added for near field, embedded Linux & file system changed	02/2013
0.718	Network configuration updated, cloud algorithm: in rare cases cloud base equals 0 m caused by division by zero, visibility: not calculated if cloud base >3000 m found, Web-Interface: Viewer: range scale corrected, NetCDF: -3 for all critical calculation errors in algorithm part, Telegram: "-3" from NetCDF is set to 'NODET', '/', '//', ..., NetCDF data synchronization to SD-Card set to 30 min; parameter "scale_factor" in different NetCDF variables corrected --> now handled as integer not as string anymore, different bug fixes	08/2013

Table 25: Firmware Releases

0.721	memory leak fixed (since 0.717) , chm watchdog implemented, NetCDF range_gate_hr implemented, manualP0, device name und Rs485 number defined	09/2013
0.722	- Status-Bit 19 added: Algorithm error, when max range detection fails - additional laser protection for cold temperatures added - scripts added for bug fix: no empty addresses in network configuration file	02/2014
0.723	- NetCDF bugfix to avoid problems in ctrl process - support for new processor board (2015)	03/2014
0.724 - 0.726	- test releases: implementation of 10 m resolution in NetCDF files, Lufft design, ...	08-11/2014
0.730	- updated cloud algorithm during precipitation events - telegram over Ethernet support, now using port 11000 - aerosol layer detection less sensitive in lower range to avoid artefacts - range parameter in webinterface and command interface implemented (RAR, RAS, RAE,RHD) - cloud detection is using new flexible range resolution to enable precise post processing - Range2DIM in RangeHRDim renamed and max. set to 600 data points - serial numbers of various components in EEPROM (opticconfig) added - new serial number of mainboard (2015 edition)	12/ 2014
0.732	- small adjustments to the cloud algorithm (lower false alarm rate below 100m; signal smoothing changes) - first averaging starts at 3 km instead of 2.2 km,+ better corresponds to met service requirements - DeviceName is preserved at reset settings to factory defaults. - Apply settings to factory defaults removed in web-interface (will be redesigned and reintegrated in future)	05/2015
0.733	- mainboard revision and processor board revision shown on web interface - service code bit 12 (laser controller temperature) combined with bit 13 (laser interlock) as new bit 13! - test firmware update for compatibility with processor board (error on service code bit 12) - decrease valid Laser optical unit temperature from 62°C to 55°C - tolerance for APD temperature warning (service code bit 26) increased, now 24°C < x < 28°C	07/2015

Table 25: Firmware Releases

0.735	<p>1) Settable altitude range enlarged to [-999m, 9999m], negative values accepted now)</p> <p>2) Settable range for RangeStart and RangeEnd changed (RangeStart from [5,3000] to [5,1000]; RangeEnd from [8000,15400] to [5500,15400])</p> <p>3) show corrected laser life time (with LaserInstallTime) on web interface and chmsettings.txt (same as in NetCDF file)</p> <p>4) new telegrams predefined: #4 (correspond to #2) and #5 (correspond to #1) with the difference that the fan and heating activities are shown at the end of the telegram and the altitude has no positive sign to allow a larger altitude range</p>	09/2015
-------	--	---------

Table 25: Firmware Releases

Fig. 1: Labelling. 10

Fig. 2: Functional chart, the numbers in brackets corresponds to the numbering in the spare parts list (refer to service manual). 15

Fig. 3: Flowchart of measuring and monitoring processes inside the FPGA. 16

Fig. 4: Drilling template. 20

Fig. 5: The CHM 15k packaged and in transporting position 20

Fig. 6: The CHM 15k with styrofoam packing pads 21

Fig. 7: Transporting by sack barrow 22

Fig. 8: Position for raising 22

Fig. 9: Fasteners 23

Fig. 10: Principal diagram 24

Fig. 11: Firefox browser to access to a CHM 15k Nimbus instrument (here with a fixed address).. 27

Fig. 12: Web interface device menu in standard user mode. The field is displayed as the first, and shows status information. A login as superuser or service user is available. 53

Fig. 13: Web interface NetCDF files (superuser): Displays a list of NetCDF files stored on the internal SD Card. NetCDF files can be downloaded by double-clicking in superuser or service mode. 54

Fig. 14: Web interface/ viewer tab: It shows the last 24h of present data. Press update to renew the pictures file. The "BackscatterMax" parameter in the config system tab (figure 17) can be changed to adjust the colour scale slightly. 54

Fig. 15: Web interface network configuration panel (service mode). The static IP address, net-mask and gateway can be changed to local network conditions. To save the settings in the Linux network configuration file and to use the new network settings the network has to be restarted. 55

Fig. 16: Web interface config network in standard (read only) mode. 55

Fig. 17: Web interface, config system upper part in service mode: access on system configuration parts. In superuser mode some parameters are not listed for security reasons. 56

Fig. 18: Web interface, tab config system lower part in service mode: access on system configuration parts. In superuser mode some parameters are not listed for security reasons. 57

Fig. 19: Web interface RS485 configuration panel (service mode): In superuser mode the upload option for a new telegram format is missing. Please ask us if you are planning to setup your own telegram file. 57

Fig. 20: Web interface: process warnings and error log, AFD status is only visible if AFD mode is on. 58

Fig. 21: Normalized signals P(r) for reference unit (blue) and a test unit (red). A horizontal path is used with a hard target in 9.4 km distance for this method. At 16 km distance a test pulses are added to the signal. 63

Fig. 22: Example for a time average used to calculate cloud bases in different

	altitudes.	64
Fig. 23:	Cloud detection algorithm.	64
Fig. 24:	Evaluation of cloud parameters, for the altitude of cloud bases and penetration depth the range vector will be corrected by the zenith angle	67
Fig. 25:	Cloud amount algorithm: The selected time interval used for the cloud cover calculation depends on the range, a truncated cone function is used for the calculation.	69
Fig. 26:	Glass panels have to be cleaned	72
Fig. 27:	Fans inlet. Remove snow, sedimentation,	72
Fig. 28:	Air dehumidifier bag (2) and rubber seal (1).	74
Fig. 29:	Start dialog window DataClient	76
Fig. 30:	Main page "Communication", where all actions are carried out. The remaining four pages serve the monitoring of the measuring data as well as service information.	77
Fig. 31:	Raw data tab. In the graph shown here the data of the last transmitted raw data telegrams are captured.	80
Fig. 32:	All types of telegrams contain cloud layer and associated penetration depths; in the advanced and raw data telegrams also the standard deviations of these values and aerosol layers are transmitted. These values are displayed on the left side. The right side shows the course of cloud heights over the last 120 (tbd) telegrams.	81
Fig. 33:	Service Codes in DataClient	82

Table 1:	Technical data	11
Table 2:	Essential commands for function testing (examples)	26
Table 3:	list of configurable device parameter; ¹ can be set in service mode; ² can be set in the web interface only, ³ can be set in terminal (RS485). 30	
Table 4:	Read only parameters, accessible via RS485 interface	32
Table 5:	Baud-rate-number-to-baud-rate assignments. Baud rates 0;1 are not specified within the time limits. 35	
Table 6:	Summary table of transfer modes.	37
Table 7:	Standard data telegram format, 1(*) = any character	38
Table 8:	Format of extended data telegrams (also refer to Table 9), 1 * = any character.	40
Table 9:	Terms in extended data telegram	42
Table 10:	Additional restrictions.	43
Table 11:	Raw data telegram format	44
Table 12:	Dimensions in NetCDF	47
Table 13:	Variables in NetCDF	47
Table 14:	Global attributes in NetCDF	50
Table 15:	Service codes/ status bits	51
Table 16:	Quality Index description, of the aerosol layer height	66
Table 17:	Cloud amount / cloud cover values related to WMO code 2700.	68
Table 18:	Sky condition index (SCI).	68
Table 19:	Cleaning schedule and cleaning action	71
Table 20:	Preventive maintenance intervals and action.	73
Table 21:	Convention of DataClient file names.	76
Table 22:	Software releases DataClient	85
Table 23:	Example of the parameter list received over RS485 interface using the command "get 16;parameter". 88	
Table 24:	CHM settings downloaded from web-interface.	90
Table 25:	Firmware Releases	93



CERTIFIED
DIN EN ISO 9001
NR 70100222
CERTIFICADO



G. Lufft GmbH, Postfach 4252, 70719 Fellbach, Germany

G. LUFFT MESS- UND
REGELTECHNIK GMBH
GUTENBERGSTR. 20
70736 FELLBACH
GERMANY

TEL.: +49 711 518 22 0
FAX: +49 711 518 22 41
EMAIL: info@lufft.com
www.lufft.com

EC Certificate of Conformity

Product: Cloud Height Meter
Type: CHM 15k (Order No. 8350.XX)

We herewith declare, represented by the signatories that the above mentioned equipment agrees with the Low Voltage Directive 2006/95/EC and the Directive of Electromagnetic Compatibility 2004/108/EC.

The following harmonized standards were considered:

EN 61010-1:2001	Safety requirements for electrical equipment for measurement, control and laboratory use – Part 1: General requirements
EN 61326-1:2006	Electrical equipment for measurement, control and laboratory use – EMC requirements – Part 1: General requirements

The following other standards / specifications were considered:

EN 60825-1:2007	Safety of laser products – Part 1: Equipment classification, requirements and user's guide
-----------------	--

Fellbach, May, 29th, 2015

Axel Schmitz-Hübsch
(Managing Director)

**G. LUFFT Mess- und
Regeltechnik GmbH**

Lufft Germany:

Fellbach Office:

Postal Address:
Gutenbergstrasse 20
D-70736 Fellbach

Address:

P.O. Box 4252
D-70719 Fellbach
Tel. +49 (0)711 - 51 822 - 0
Fax +49 (0)711 - 51 822 - 41
www.lufft.com
info@lufft.de

Berlin Office:

Oderstr. 59
D-14513 Teltow
Phone: +49 711 51822-831
Fax: +49 711 51822-944

a passion for precision · passion pour la précision · pasión por la precisión · passione per la precisione ·

Lufft North America:

Lufft USA, Inc.

820 E Mason St #A
Santa Barbara, CA 93103
Tel.: +01 919 556 0818
Fax: +01 805 845 4275
E-Mail: sales@lufftusainc.com
www.lufft.com

Lufft China:

Shanghai Office:

Lufft (Shanghai)
Measurement & Control
Technology Co., Ltd.
Room 507 & 509, Building No.3,
Shanghai Yinshi Science and
Business Park,
No. 2568 Gudai Road,
Minhang District,
201199 Shanghai, CHINA
Tel: +86 21 5437 0890
Fax: +86 21 5437 0910
E-Mail: china@lufft.com
www.lufft.cn

Beijing Office:

B501 Jiatai International Mansion
No. 41 East 4th Ring Road,
Chaoyang District,
100025 Beijing, CHINA
Tel: +86 10 65202779
Fax: +86 10 65202789
E-Mail: china@lufft.com

